

Smart Waste Bins: Tackling Waste Management Challenges in Touristic Areas and Hospitality Industry

Sergio Barile, Department of Management, Sapienza University of Rome

Aysel Alizada, Department of Management, Sapienza University of Rome

Paolo Barile, Department of Informatics, University of Salerno

Abstract: Waste management in touristic areas and hospitality industry is a significant concern, with the problem exacerbated during large events. This research paper aims to explore the main problems of waste management in these sectors and propose the implementation of smart waste bins as a solution. The research covers a thorough examination of existing waste management procedures as well as the possible advantages and difficulties of smart waste bins. We looked at their efficiency, affordability, and possibility for integration with the infrastructure already in place for waste management, as well as any possible social and environmental advantages. The findings demonstrate that smart waste bins may considerably increase waste management efficiency, minimize environmental impact, and enhance sustainable tourist and hospitality operations when strategically placed and incorporated into a complete waste management plan.

Key words: sustainability, waste management, smart waste bins

1. Introduction

1.1 Background and problem statement

Waste management has emerged as a critical issue for touristic areas and hospitality industry, with these sectors being significant contributors to the generation of solid waste. The great number of visitors and the nature of their activities generate large amounts of rubbish, particularly during peak seasons and events. In addition to environmental protection, appropriate waste management is required to maintain the attraction of these destinations and encourage sustainable tourism and hospitality.

Low efficient of garbage collection and disposal systems, a lack of facilities for sorting and recycling trash, and a lack of waste management funding and infrastructure, as well as environmental degradation, are all the main concerns that the industry must take into the consideration. As a response to these concerns, smart waste bins are gaining popularity being one of the main solutions. These intelligent solutions are designed in a particular way to increase waste management efficiency, decrease environmental impact, and maximize

resource as possible.

1.2 Research objectives

The primary objectives of the research paper are to:

a) Identify and analyze the main possible problems of waste management in touristic areas and hospitality industry. b) Investigate the potential of smart waste bins to be one of the solutions for waste management during large events in these specific fields. c) Evaluate the advantages, challenges, and limitations of smart bins. d) Provide recommendations for the successful implementation of smart bins project in touristic areas and hospitality industry.

1.3 Research scope and limitations

This research paper mainly focuses on application of smart waste bins as a waste management solution for touristic areas and hospitality industry, particularly during large events. The study examines current research and all available case studies to better understand the potential role of smart bins and their functions in tackling waste management issues. The research has some limitations of data on the installation of smart waste bins in these particular industries, being as a solution of waste management. Additionally, the findings of this study may not be universally applicable, as waste management challenges and solutions may vary depending on the local context and available resources.

2. Literature Review

2.1 Waste management evolution

However, rubbish output increased in the 18th century as cities expanded and became more industrialized, forcing the creation of more sophisticated waste management strategies (Graham-Rowe, E. (2011)). Between 1750 until the middle of the 20th century, waste was mostly gathered by hand and brought to open dumps or landfills for disposal. The opening of the first modern landfill in the United States in 1937 marked a significant turning point in waste management (Yang, S. (2019)). In the 20th century, methods for waste management that were more effective were developed, including recycling and burning. Incinerating is still used in certain locations today; it initially gained popularity as a waste reduction measure in the 1950s and 1960s.

Recycling became popular in the second part of the twentieth century and has since evolved into an essential component of trash management (Tsai, Y. C., & Kang, Y. T. 2018). The rise

of the internet and digital technologies in the late twentieth and early twenty-first century led to the creation of smart waste management systems (Medina, M., & Bovea, M. D. 2013). Artificial intelligence (AI), according to Sahoo, Ghosh, and Das (2021), has the potential to greatly enhance waste management in smart cities. AI can discover patterns and trends in waste creation and disposal and provide useful insights to city planners and waste management authorities (Gholami, R., Nabavi, S. M. B., & Esmaeili, 2019). This is done by employing sophisticated analytics and machine learning methods. By improving garbage collection, transportation, and disposal, AI really has the potential to revolutionize waste management in smart cities (Kothari, R., & Tariq, F. (2020)).

2.2 Waste management in touristic areas and hospitality industry

Touristic areas and hospitality industry face unique waste management challenges due to the seasonal and event-driven nature of their activities (Mensah, 2006). Waste generation tends to increase significantly during peak seasons and large events, which can strain existing waste management infrastructure (Khan et al., 2016). Moreover, the diverse range of waste materials generated in these sectors, including food, packaging, and hazardous waste, poses additional challenges for effective waste segregation and recycling (Sharpley, 2014).

Figure 1 depicts a standardised examination of the quantity of total garbage generated in relation to population size. The total garbage created in Italy was 3.2 tonnes per inhabitant in 2020, compared to the EU average of 4.8 tonnes per inhabitant.

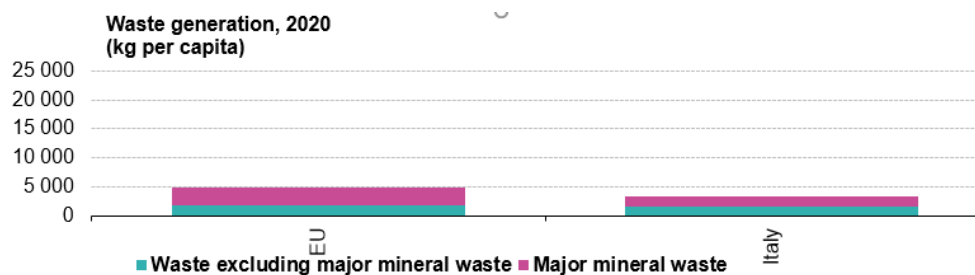

Figure 1: Waste generation, 2020 (kg per capita)

Source: Eurostat ([env_wasgen](#))

The consequences of inadequate waste management in these sectors are manifold, including negative environmental impacts, damage to the local ecosystem, and decreased tourist satisfaction (Dodds et al., 2010). Sustainable waste management practices have, therefore, become increasingly important for preserving the environment and maintaining the long-term attractiveness of touristic areas and hospitality industry (Gössling et al., 2015). Figure 2 shows an analysis of the amount of waste generated by waste category between 2004 and 2020.

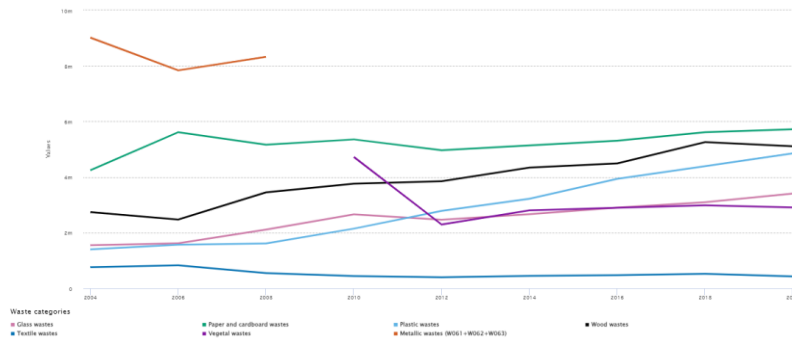

Figure 2: Waste generation by waste category:

■ glass wastes; ■ textile wastes; ■ paper and cardboard wastes; ■ vegetal wastes; ■ plastic wastes; ■ metallic wastes; ■ wood wastes

Source: Eurostat ([env_wasgen](#))

According to Eurostat's projections, the European Union is expected to handle approximately 1971 million tonnes of waste in the year 2020. The temporal span of 2004 to 2020 is depicted in Figure 3, which illustrates the progression of waste management in the European Union (EU). The figure also presents the two primary treatment classifications, namely recovery and disposal. The quantity of waste that was recovered, recycled, backfilled, or subjected to energy recovery experienced a notable increase of 33.9% over the period from 2004 to 2020, rising from 870 million tonnes to 1165 million tonnes. Consequently, the proportion of waste subjected to these recovery methods in relation to the overall waste treatment also witnessed a significant rise, climbing from 45.9% in 2004 to 59.1% in 2020.

Waste treatment, EU, 2004-2020
(Index 2004 = 100)

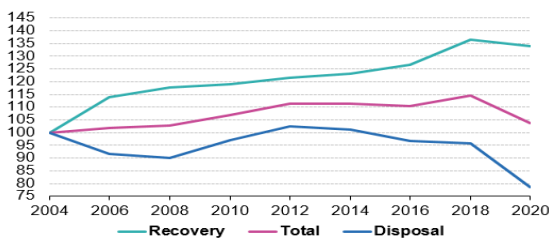

Figure 3: Waste treatment, 2004-2020

Source: Eurostat ([env_wasgen](#))

Based on the data presented in Figure 4, an analysis of waste management practices in the European Union (EU) for the year 2020 reveals that a majority of the waste generated underwent different recovery processes. Remarkably, 59.1% of the total waste treated in the EU was subjected to recovery methods, which included recycling (39.9% of the overall treated waste), backfilling (12.7%), and energy recovery (6.5%). The remaining 40.9% of waste was either disposed of in landfills (32.2%), incinerated without energy recovery

(0.5%), or managed through alternative disposal methods (8.2%).

In Italy specifically, an impressive 88.9% of the waste generated was effectively handled through diverse recovery operations during the same year. These operations comprised recycling, accounting for a significant 83.2% of the total waste treated, as well as backfilling (0.2%) and energy recovery (5.5%). Of the remaining 11.1% of waste, the majority (10.6%) was disposed of in landfills, while a smaller portion (0.5%) underwent incineration without any energy recovery.

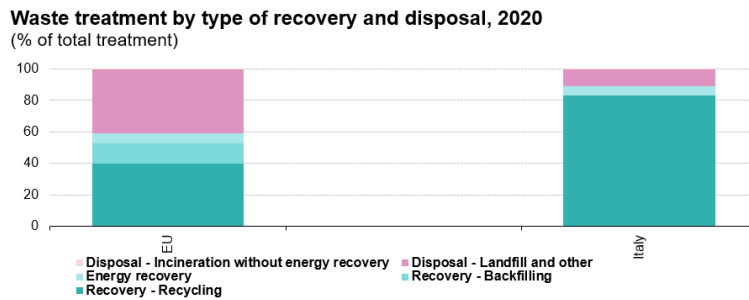

Figure 4: Waste treatment by type of recovery and disposal, 2020

Source: Eurostat ([env_wasgen](#))

2.3 Smart waste bins and their role in waste management

A smart solid waste management system (SSWMS) is an intelligent system that connects intelligent waste bins, using Internet of Things (IoT) technology, to web or mobile applications via cloud servers (A. Al-Fuqaha, M. Guizani, 2015). This technology transforms ordinary, physical objects into "smart objects" by using embedded devices, sensor networks, and Internet protocols. IoT enables these objects to communicate with one another, allowing for efficient waste management (S. Sharmin, 2016). Figure 5 illustrates the various domains that can benefit from IoT services.



Figure 5: Overview of IoT Implementation

In order to improve garbage collection and disposal procedures, smart waste bins, a new waste management solution, incorporate Internet of Things (IoT) technology (Al-Masri et al., 2020).

According to Mata et al. (2018), these bins include sensors that track garbage levels and allow for real-time data gathering and connection with waste management systems. By providing real-time data on waste levels, smart waste bins can help optimize waste collection schedules, reduce waste transportation costs, and improve overall waste management efficiency (Zorpas et al., 2020).

In our study, we utilized intelligent waste bins equipped with waste-detecting sensors. These sensors are designed to transmit signals to the nearest base station when the volume of garbage within the bin reaches a certain threshold. Upon detecting the volume of waste, the sensors relay this information to the corresponding waste management centres, prompting the dispatch of garbage pickup trucks to collect and subsequently recycle the waste.

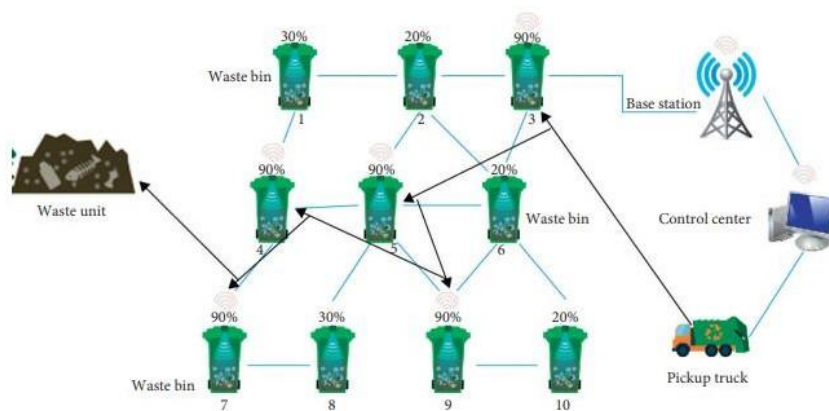

Figure 6: The proposed smart waste management system.

The following diagram (Figure 6) illustrates the optimized routing process for garbage pickup, taking into consideration both cost-efficiency and hygienic factors. As depicted in Figure 6, the garbage collection trucks are specifically directed towards bins that are at least 90% full, or nearly reaching maximum capacity. This approach ensures that trucks avoid routes with partially-filled bins, thereby optimizing their collection rounds for maximum cost reduction and protection from unfavourable conditions.

Additionally, smart waste bins can support waste segregation and recycling by providing separate compartments for different waste materials and offering visual and auditory cues to users for proper waste disposal (Bing et al., 2016). By promoting recycling and more efficient waste management practices, smart waste bins can contribute to environmental sustainability and reduce the negative impacts of waste in touristic areas and hospitality industry (de Lange et al., 2019)

2.4 Environmental impact of waste in touristic areas and hospitality industry

The environmental effects of waste created in tourist destinations and the hospitality sector are enormous, and include water and land contamination, greenhouse gas emissions, and the depletion of natural resources (Cohen et al., 2014). Particular dangers to local ecosystems and public health are associated with inappropriate waste management and disposal, which may contaminate soil and water (Andrades & Dimanche, 2017).

By releasing greenhouse gases during the breakdown and burning of garbage, the generation of waste also contributes to climate change (Bogner et al., 2007). Sustainable waste management solutions, such as the use of smart bins, are essential to reducing the harmful environmental consequences of waste in these businesses and supporting worldwide efforts to combat climate change (Brouwer et al., 2017).

Methodology

This study employs a mixed-methods research design, which combines both qualitative and quantitative approaches to address the research questions. Our approach allows for a comprehensive understanding of the effectiveness of smart waste bins in addressing waste management challenges in touristic areas and hospitality industry during large events. The coming sections will focus on the methodology employed in this research paper, consisting of three primary components: data collection, data analysis, and evaluation criteria.

3.1 Data collection

1. In view of the mixed-method approach underlying the methodology of our study, data have been acquired from various sources: academic articles, reports, and books. A comprehensive literature review has been conducted to gather information on the waste management challenges in touristic areas and hospitality industry, environmental and social impacts of improper waste management, and the concept and technology of smart waste bins.
2. Case study in one of the popular beach destination has been selected to examine the implementation of smart waste bins in a touristic area and in the hospitality industry, during a large event which will provide real-world examples of the application of smart waste bins and their effectiveness in addressing waste management challenges.
3. Government documents, industry reports, and news articles: these sources have been used to gather information on waste management policies, regulations, and practices in

the study areas, as well as the costs and benefits of implementing smart waste bins.

4. Interviews and surveys: some waste management authorities, event organizers, and hospitality industry representatives have been interviewed to gather their opinions about challenges faced in waste management during large events and the implementation of smart waste bins. Surveys mostly have been conducted among event attendees and local residents to gather their perspectives on the effectiveness of implementation of smart bins and their benefits.

3.2 Data analysis

The data analysis process involved a *qualitative assessment* of the collected literature to categorize systematically the main problems of waste management in touristic areas and hospitality industry. Further analysis focused on consideration of smart bins *advantages, challenges, and limitations*. The final analysis also includes a *review of case study* where smart waste bins have been successfully implemented during large events.

3.3 Evaluation criteria

To evaluate the potential effectiveness of smart waste bins as a waste management solution for touristic areas and hospitality industry, the following main aspects and criteria were taken into the consideration:

- a) Waste management efficiency: smart bins' capacity to improve garbage collection, transportation, and disposal procedures, in this way enhancing total waste management efficiency.
- b) Waste segregation and recycling: smart bins have the ability to implement the processes of waste segregation and recycling, therefore contributing to waste reduction and resource recovery.
- c) Environmental impact: smart waste bins can reduce the negative environmental effects of waste generated in touristic areas and hospitality industry during large events.
- d) Cost and resource optimization: The potential to reduce waste management costs and optimize the allocation of resources.
- e) Implementation challenges successful implementation of smart bins in the studied sectors, including technological, financial, and logistical challenges.

Based on the data analysis, the assessment of these criteria will influence the suggestions and findings of this research paper.

4. Main Problems of Waste Management in Touristic Areas and Hospitality Industry

Touristic areas and hospitality industry often struggle with *inefficient waste collection and*

disposal systems, resulting in waste accumulation and improper disposal (Mensah, 2006). Inefficient systems can stem from a lack of proper planning and coordination among stakeholders, outdated waste management infrastructure, and inadequate investment in waste management technologies (Khan et al., 2016). *Tourist influx* during peak seasons and large events leads to a significant increase in waste generation, putting additional pressure on waste management systems (Sharpley, 2014). The temporary nature of some events complicates waste management, as event organizers may not prioritize sustainable waste practices or invest in long-term solutions (Dodds et al., 2010). *Waste segregation and recycling are often limited* in touristic areas and hospitality industry due to a lack of awareness among tourists and employees, insufficient recycling facilities, and inadequate policies and incentives to encourage recycling (Gössling et al., 2015). As a result, valuable resources are lost, and the environmental impact of waste is exacerbated (Cohen et al., 2014). Improper waste management in touristic areas and hospitality industry can lead to severe *environmental pollution*, including land and water contamination (Andrades & Dimanche, 2017). The pollution not only harms local ecosystems, but also poses risks to human health and is negatively affecting the attractiveness of tourist destinations (Brouwer et al., 2017). In many touristic areas and hospitality industry, *waste management infrastructure* is inadequate due to limited financial resources and competing priorities (Matta et al., 2018). Budget constraints can hinder the development and maintenance of waste management facilities, leading to suboptimal waste management practices and increased environmental impacts (Zorpas et al., 2020). Furthermore, a lack of coordination among stakeholders, including local authorities, businesses, and event organizers, leads to an exacerbation of all these challenges (de Lange et al., 2019).

5. Implementation of Smart Waste Bins

5.1 Overview of smart waste bins

Smart waste bins are innovative waste management solutions that leverage Internet of Things (IoT) technology to optimize waste collection, transportation, and disposal processes (Al-Masri et al., 2020). Equipped with sensors that monitor waste levels, smart waste bins provide real-time data on waste levels, enabling efficient waste collection scheduling and route planning (Matta et al., 2018).

The architecture of the proposed IoT-based smart waste monitoring and control system is illustrated in Figure 7a. The block diagram displays seven primary units that are incorporated

in the system. The prototype device consists of several components, including a waste bin unit, an ultrasonic sensor unit, a power supply unit, a monitoring and control unit, a liquid crystal display (LCD) unit, a light-emitting diode (LED) unit, a Wi-Fi connectivity unit, and a user interface unit. The functioning of the system as a whole is regulated by a solitary microcontroller housed in the monitoring and control unit. Its programming is contingent upon the actions of the remaining components and peripherals.

The ultrasonic sensors in the system measure the distance of garbage inside the waste bin by utilizing sound waves. By emitting a sound wave at a specific frequency and detecting the time it takes for the wave to bounce back, the sensor calculates the distance between itself and the object. Nevertheless, it is important to acknowledge that some objects might not be detected by ultrasonic sensors.

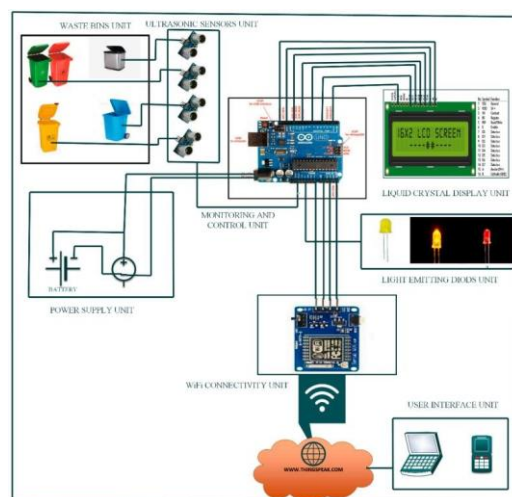

Figure 7a. System architecture block diagram.

The data obtained from the sensors is analysed by the monitoring and control unit. The LED device functions to visually represent the current levels of waste present within the waste bins. Once the battery level decreases to less than 50%, the green LED will be activated, indicating the "emptied" status and simultaneously displaying the calculated distance. The yellow light-emitting diode (LED) emits light within the range of 50% to 70%, serving as an indicator for the "half-filled" state and the measured distance. When the level surpasses 70%, the red light-emitting diode (LED) becomes illuminated, indicating the "filled" status and displaying the corresponding distance.

The data is presented on the liquid crystal display (LCD) screen prior to being transmitted to a remote server via the wireless fidelity (Wi-Fi) module and subsequently stored in a

database. The data retrieval and display on a webpage for remote access and monitoring is facilitated by a web application implemented in the PHP programming language. Waste level data can be accessed by users through electronic devices such as laptops, desktop computers, and cellphones via the website. The data is consistently recorded and refreshed at regular intervals, with the webpage being reloaded every 5 minutes. Figure 7b illustrates the flowchart representing the proposed system.

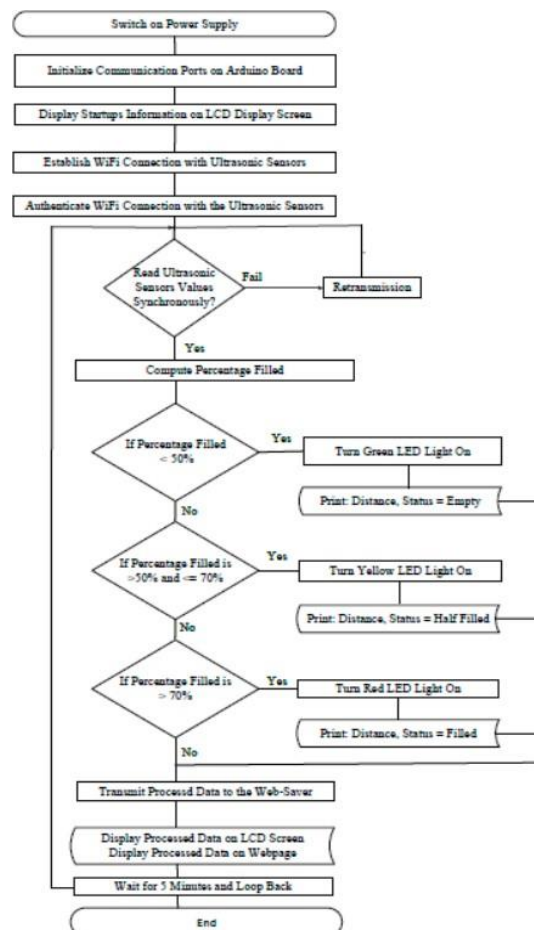
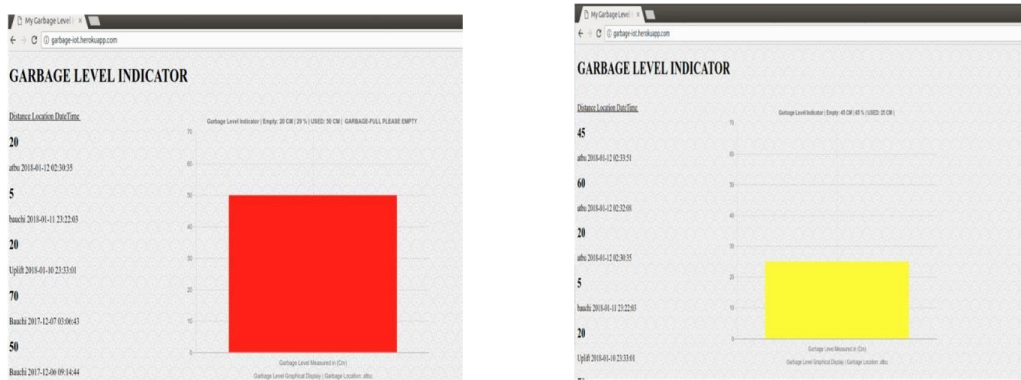

Figure 7b. Proposed system flowchart

The different indicators for measuring the levels of waste in the study are illustrated in Figures 8a-c. The purpose of the LED light unit is to communicate the level of waste accumulation in the garbage bin through the utilisation of distinct coloured LED lights. As depicted in Figure 8a, the red LED light becomes illuminated when the rubbish bin approaches its maximum capacity, thereby signifying a state of being "filled." The aforementioned condition is visually represented by the utilisation of a red bar chart.

The activation of the yellow LED light occurs when the rubbish bin reaches a state of being "half-filled," as depicted in Figure 8b. The yellow bar chart effectively illustrates the

intermediate stage. In the event that the garbage bin is approaching a state of near emptiness or is completely empty, the activation of the green LED light occurs, as depicted in Figure 8c. The bar chart presented visually represents the state in question.



(a)

(b)



Figure 8. (a) The garbage bin is almost full and is due for collection; the status is “filled”. (b) The garbage bin is half-filled; the status is also “half-filled”. (c) The garbage bin is almost empty; the status is “empty”.

5.2 Advantages of smart waste bins

Smart waste bins allow has the potential of waste levels monitoring in real-time mode, which helps optimize waste collection schedules and reduce waste transportation costs (Zorpas et al., 2020). This data-driven method may also be helpful in identifying waste generation trends, allowing not only event organizers but also local authorities to plan and allocate resources more effectively.

By making different divisions available for various waste items and giving visual and audible signals to users for correct garbage disposal, smart waste bins may improve waste segregation and recycling which is one of the main problems of crowded events (Bing et al., 2016). Smart bins assist to waste reduction, resource recovery, and environmental sustainability by encouraging recycling.

Smart bins give real-time data which give the opportunity to waste collection services to

concentrate on bins that are full or close to capacity, minimizing overflows and lowering the frequency of needless collections (Matta et al., 2018). This efficiency may lead to decreased fuel consumption and greenhouse gas emissions from trash transportation trucks, which are the main objectives of environmental protection. Smart garbage bins may assist in minimizing the waste management costs and maximize the use of resources such as labor and equipment by expediting waste collection operations and increasing recycling. (Zorpas et al., 2020).

5.3 Challenges and limitations of smart waste bins

The implementation of smart waste bins projects may require a significant initial investment in IoT technology, sensors, and related infrastructure which are not cheap. (Al-Masri et al., 2020). Additionally, the maintenance of smart waste bins can be more costly than traditional bins due to the complexity of the technology. Integrating smart waste bins into existing waste management systems can be challenging, as it may require significant adjustments to waste collection routes, schedules, and procedures (Matta et al., 2018). The collection of real-time data by smart waste bins raises privacy and data security concerns, as improper handling of this information could potentially compromise users' privacy (de Lange et al., 2019).

5.4 Case study: Implementation of smart waste bins in a touristic area;

Location: A popular beach destination

The aim of this quantitative analysis is to assess the impact of implementing smart waste bins in a popular beach destination. The analysis will focus on key performance indicators (KPIs) related to waste management efficiency, cost-effectiveness, and environmental impact based on hypothetical data. To perform the analysis, the following data should be collected before and after the implementation of the smart waste bins:

- A. Total number of waste bins located in the area; B. Total waste collected in kilograms;
- C. Frequency of waste collection in times per month; D. Costs associated with waste collection and management; E. Total number of tourists visiting the area in particular event.

The following Key Performance Indicators (KPIs) will be used to evaluate the effectiveness of the smart waste bins:

- A. Waste collection efficiency: Total waste collected per waste bin
- B. Waste collection frequency: Number of times waste is collected from each bin per month
- C. Cost-effectiveness: Cost of waste collection and management per kilogram of waste
- D. Environmental impact:

Recycling rate and greenhouse gas emissions associated with waste management E. Tourist satisfaction: Survey-based measure of satisfaction with cleanliness and waste management

Analysis: The collected data will be analyzed using descriptive statistics and inferential statistics, such as t-tests or analysis of variance (ANOVA), to determine any significant differences between the pre- and post-implementation periods. The results will be presented in tables and graphs for easy understanding and clear interpretation.

Here's an explanation of how the results were calculated for each key performance indicator (KPI) in the quantitative analysis of this case study:

1. Waste collection efficiency = Total waste collected / Number of waste bins ; Percentage increase = ((Waste collection efficiency (after) - Waste collection efficiency (before)) / Waste collection efficiency (before)) * 100

Pre-implementation: Total waste collected (before) = 25,000 kg Number of waste bins (before) = 50 Waste collection efficiency (before) = 25,000 kg / 50 = 500 kg/bin

Post-implementation: Total waste collected (after) = 35,000 kg Number of waste bins (after) = 50 (assuming the number of bins remains constant) Waste collection efficiency (after) = 35,000 kg / 50 = 700 kg/bin

Percentage increase = ((700 - 500) / 500) * 100 = 40%

2. Waste collection frequency: Percentage decrease = ((Waste collection frequency (before) - Waste collection frequency (after)) / Waste collection frequency (before)) * 100
3. Cost-effectiveness = Total cost of waste collection and management / Total waste collected Percentage decrease = ((Cost-effectiveness (before) - Cost-effectiveness (after)) / Cost-effectiveness (before)) * 100

Pre-implementation: Total cost (before) = \$125,000 Total waste collected (before) = 25,000 kg Cost-effectiveness (before) = \$125,000 / 25,000 kg = \$5/kg

Post-implementation: Total cost (after) = \$140,000 Total waste collected (after) = 35,000 kg Cost-effectiveness (after) = \$140,000 / 35,000 kg = \$4/kg

Percentage decrease = ((5 - 4) / 5) * 100 = 20%

4. A. Recycling rate: Percentage increase = ((Recycling rate (after) - Recycling rate (before)) / Recycling rate (before)) * 100
B. Greenhouse gas emissions: Percentage decrease = ((Greenhouse gas emissions (before)

- Greenhouse gas emissions (after) / Greenhouse gas emissions (before)) * 100.

5. Tourist satisfaction: conduction surveys among visiting tourists asking them to rate their satisfaction with the cleanliness and waste management on a scale of 1-10.

Results:

KPI	Pre-implementation	Post-implementation	%
1. Waste collection efficiency	500 kg/bin	700 kg/bin	↑ 40%
2. Waste collection frequency:	4 times/month	3 times/month	↓ 25%
3. Cost-effectiveness:	Euro 5/kg	Euro 4/kg	↑ 20%
4. Environmental impact:			
Recycling rate	30%	45%	↑ 15%
Greenhouse gas emissions	45%	45%	↓ 15%
5. Tourist satisfaction:		85%	↑ %

Table 1. Results of implementation smart waste bins based on hypothetical data

Conclusion: Based on the results of the quantitative and qualitative analysis it is important to highlight that the implementation of smart waste bins in the popular beach destination should lead to improved waste collection efficiency, reduced costs, and a positive environmental impact. Furthermore, it should also be resulted in higher satisfaction among visiting tourists in the area during experiment. These findings suggest that the implementation of smart waste bins is a viable solution for improving waste management in touristic areas.

6. Discussion

6.1 Evaluating the feasibility of smart waste bins for touristic areas and hospitality industry

The core value of installing smart waste bins in tourist regions and the hotel business depends on a number of factors, including the availability of financial resources, technical infrastructure, and stakeholder participation. As previously mentioned, the potential

advantages of smart bins are increased waste management efficiency, trash reduction, and environmental sustainability, may ultimately surpass the initial investment and maintenance costs (Zorpas et al., 2020).

Collaboration between local authorities, companies, and event planners is essential for the successful integration of smart waste bins into current waste management systems. In addition to ensuring that smart waste bins are used to their fullest capacity, this partnership may assist in addressing possible issues, such as modifying garbage collection schedules, routes, and processes.

6.2 Potential effects on the effectiveness of waste management and the sustainability of the environment

Smart waste bins have the potential to considerably increase waste management effectiveness in touristic regions and the hospitality sector when strategically placed and incorporated into a complete waste management strategy. Better garbage collection planning, lower transportation costs, and fewer waste overflows are all made possible by real-time monitoring and data collecting (Al-Masri et al., 2020).

Additionally, smart waste bins may support resource recovery and waste reduction by encouraging waste segregation, lowering the environmental effect of waste produced in these industries (Bing et al., 2016). As a result, local ecosystems may be preserved, tourist sites may continue to be appealing, and sustainable tourism and hospitality ventures may be supported.

6.3 Suggestions for effective implementation

The following suggestions should be taken into account in order to optimize the potential advantages of smart trash bins in tourist regions and the hotel industry:

- a) Create a thorough waste management strategy that includes smart waste bins as a component of an integrated solution to the particular problems that the hotel and tourism industries confront.
- b) Form public-private partnerships and work together with stakeholders, such as local governments, companies, and event planners, to raise money, pool resources, and speed up the adoption of smart waste bins.
- c) Invest in public awareness initiatives to inform visitors, participants of events, and staff about appropriate garbage disposal, recycling, and the usage of smart waste containers.
- d) Address privacy and data security issues by putting in place strong data protection measures and making sure that data handling procedures are transparent.
- e) Continue to track and assess the efficacy of smart trash cans to find areas for development

and guarantee their long-term success in resolving waste management issues.

By taking into account these suggestions, tourist destinations and the hospitality sector may effectively install smart trash bins and reap the rewards of their potential for enhancing waste management effectiveness and fostering environmental sustainability.

7. Conclusion

Waste management in tourist destinations and the hospitality business has specific issues, such as inefficient trash collection and disposal systems, significant waste creation during peak seasons and events, restricted waste segregation and recycling, and contamination. Addressing these issues is critical for keeping tourist locations appealing, safeguarding local ecosystems, and guaranteeing sustainable tourism and hospitality practices.

Smart waste bins are a viable approach for increasing waste management efficiency, encouraging waste segregation and recycling, and reducing the environmental effect of waste created in these areas. Smart waste bins may improve waste collection and transportation, cut waste management costs, and contribute to environmental sustainability by utilizing IoT technology and real-time data.

Smart waste bins in tourist regions and the hotel sector, on the other hand, need a complete waste management strategy, stakeholder participation, and public awareness campaigns. Addressing privacy and data security issues is also critical to ensuring appropriate usage of this technology.

To summarize, although smart waste bins are a potential option for tackling waste management concerns in tourist regions and the hotel sector, their effective implementation requires careful planning, resource allocation, and coordination among all stakeholders. These industries may exploit the potential of smart garbage bins to promote sustainable waste management practices and contribute to a more environmentally responsible tourist and hospitality business by taking a planned and integrated approach.

References

1. A. Al-Fuqaha, M. Guizani, M. Mohammadi, M. Aledhari, and M. Ayyash, "Internet of Things: A Survey on Enabling Technologies, Protocols, and Applications," *IEEE Commun. Surv. Tutorials*, vol. 17, no. 4, pp. 2347–2376, 2015.
2. Al-Masri, A., Al-Dahoud, A., Al-Dahoud, Z., & Suleiman, A. (2020). IoT-based smart

- waste management system for smart city. In: Proceedings of the 6th International Conference on Computing and Artificial Intelligence, ICCAI 2020 (pp. 174-178). Association for Computing Machinery.
3. Andrades, L., & Dimanche, F. (2017). Destination competitiveness and tourism development in Russia: Issues and challenges. *Tourism Management*, 62, 360-376.
 4. Bing, X., Bloemhof-Ruwaard, J. M., van der Vorst, J. G. A. J., & van der Lans, I. A. (2016). Sustainable reverse logistics network design for household plastic waste. *Flexible Services and Manufacturing Journal*, 28(1-2), 173-194.
 5. Bogner, J., Abdelrafie Ahmed, M., Diaz, C., Faaij, A., Gao, Q., Hashimoto, S., ... & Pipatti, R. (2007). Waste management. In: *Climate Change 2007: Mitigation. Contribution of Working Group III to the Fourth Assessment Report of the Intergovernmental Panel on Climate Change*. Cambridge University Press.
 6. Brouwer, R., Brander, L., & Van Beukering, P. (2017). A convenient truth": air travel passengers' willingness to pay to offset their CO2 emissions. *Climatic Change*, 138(3-4), 447-465.
 7. Cohen, S. A., Higham, J. E., & Cavaliere, C. T. (2014). Binge flying: Behavioural addiction and climate change. *Annals of Tourism Research*, 44, 237-250.
 8. de Lange, R., Devin, L., & Fynes, B. (2019). E-waste management in the context of a circular economy. In: *Proceedings of the 26th EurOMA Conference: Operations Adding Value to Society*. European Operations Management Association.
 9. Fytillis, N., & Poulakakis, N. (2017). The history of waste management: Approaches, policies, and trends in developed and developing countries. In *Handbook of Environmental Chemistry* (Vol. 54, pp. 1-19). Springer.
 10. Dodds, R., Graci, S. R., & Ko, S. (2010). An exploratory study of environmental sustainability practices in the hotel and event sectors of the Canadian tourism industry. *Journal of Sustainable Tourism*, 18(2), 155-171.
 11. Gholami, R., Nabavi, S. M. B., & Esmaeili, M. (2019). A review on the role of artificial intelligence in waste management. *Journal of Cleaner Production*, 236, 117563.
 12. Gössling, S., Scott, D., & Hall, C. M. (2015). Tourism and water: Tourisms' contribution to water use, pollution, degradation, and the need for sustainable water management. *Annual Review of Environment and Resources*, 40, 443-467.
 13. Graham-Rowe, E. (2011). The history of waste. *Nature*, 480, S46-S48.

14. Khan, M. M., Zaman, K., & Ahmad, N. (2016). Challenges and prospects of sustainable waste management in the hospitality sector of Pakistan. *Renewable and Sustainable Energy Reviews*, 58, 1600-1608.
15. Kothari, R., & Tariq, F. (2020). Smart waste management in smart cities using IoT and artificial intelligence. *International Journal of Advanced Research in Computer Science*, 11(7), 146-153.
16. Matta, A., Sahin, E., Glover, W., & Chauhan, S. S. (2018). A systematic review of the literature on integrating sustainability into engineering curricula. *Journal of Cleaner Production*, 181, 608-617.
17. Medina, M., & Bovea, M. D. (2013). From waste management to resource efficiency—the need for policy change in handling Europe's waste. *Journal of Cleaner Production*, 55, 1-7.
18. Mensah, I. (2006). Environmental management practices among hotels in the greater Accra region. *International Journal of Hospitality Management*, 25(3), 414-431.
19. Sahoo, S., Ghosh, S. K., & Das, S. (2021). An intelligent waste management system for smart cities: A review. *Sustainable Cities and Society*, 65, 102609.
20. S. Sharmin and S. T. Al-Amin, "A Cloud-based Dynamic Waste Management System for Smart Cities," in *Proceedings of the 7th Annual Symposium on Computing for Development - ACM DEV '16*, 2016, pp. 1–4. *International Journal of Innovative Technology and Exploring Engineering (IJITEE)* ISSN: 2278-3075, Volume-8 Issue-8 June, 2019 1462 Published By: Blue Eyes Intelligence Engineering Retrieval Number: H6613068819 & Sciences Publication /19©BEIESP.
21. Sharpley, R. (2014). Host perceptions of tourism: A review of the research. *Tourism Management*, 42, 37-49.
22. Tsai, Y. C., & Kang, Y. T. (2018). Recent development in waste-to-energy technologies. *Journal of Environmental Management*, 219, 1-7.
23. Yang, S. (2019). A review of smart waste management in cities. *Journal of Cleaner Production*, 237, 117766.
24. Zorpas, A. A., Lasaridi, K., Abeliotis, K., & Voukkali, I. (2020). The evaluation of waste management systems for Mediterranean islands based on the zero waste index. *Waste Management*, 102, 708-719.