



Operations Manual

OM 1063-3

Group: **Controls**

Part Number: **OM 1063**

Date: **January 2018**

Supercedes: **OM 1063**

Daikin VAV Controller Model 250802400

Owner's Manual

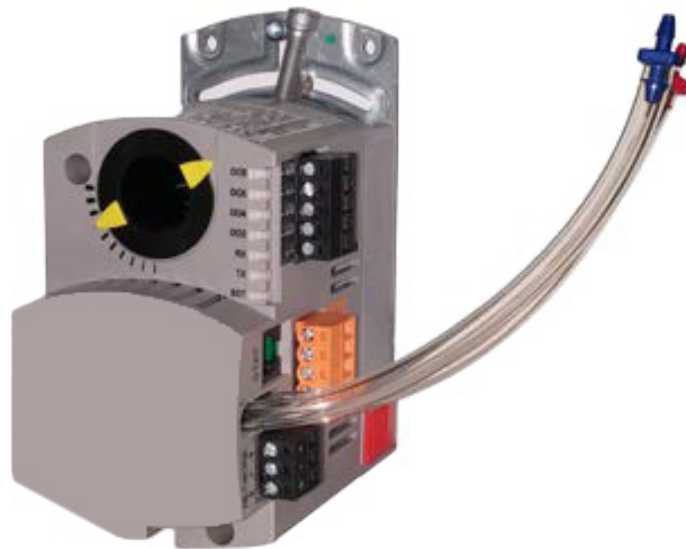

Introduction	3	BACnet Points List	16
Revision History	3	Overview	16
How To Use This Manual	3	Troubleshooting	21
Product Overview	4	Basic Service Information	21
Hardware Inputs	4	WCIS Cable and Software	21
Hardware Outputs	5	Preventive Maintenance	21
Power Wiring	5	Safety Features	21
Communication Wiring	6	Controller LEDs	21
Controller LED Indicators	6	Automated Fault Detection and Diagnostics (Checkout)	21
Applications and Features	7	Glossary	24
Occupancy	7	Overview	24
Control Loops	7		
Calibration	7		
Controller Self-Regulation and Maintenance	8		
Automated Fault Detection and Diagnostics (Checkout)	8		
Application 6630 VAV Cooling Only	9		
Application 6631 VAV Cooling or Heating	10		
Application 6632 VAV with Electric Reheat or Baseboard Radiation	11		
Application 6633 VAV with Hot Water Reheat	12		
Application 6634 and 6636 VAV Series Fan or Parallel and Electric Heat	13		
Application 6635 and 6637 VAV Series Fan or Parallel Fan and Hot Water Reheat	14		
Application 6684 Slave Mode	15		
Using the Controller as a Point Extension Device	15		

Notice

The information contained within this document is subject to change without notice and should not be construed as a commitment by Daikin Applied. Daikin Applied assumes no responsibility for any errors that may appear in this document.

All software described in this document is furnished under a license and may be used or copied only in accordance with the terms of such license.

Warning

This equipment generates, uses, and can radiate radio frequency energy and if not installed and used in accordance with the instructions manual, may cause interference to radio communications. It has been tested and found to comply with the limits for a Class B digital device, pursuant to Part 15 of the FCC rules. These limits are designed to provide reasonable protection against such interference when operated in a commercial environment. Operation of this equipment in a residential area is likely to cause interference in which case users at their own expense will be required to take whatever measures may be required to correct the interference.

Service Statement

Control devices are combined to make a system. Each control device is mechanical in nature and all mechanical components must be regularly serviced to optimize their operation. All Daikin Applied branch offices and authorized distributors offer Technical Support Programs that will ensure your continuous, trouble-free system performance.

For further information, contact your nearest Daikin Applied representative.

Credits

Product or company names mentioned herein may be the trademarks of their respective owners.

Revision History

Publication	Date	Release Notes
OM 1063-3	January 2018	Updated cover image, title, and Figure 3
OM 1063-2	January 2017	Updated for actuator with new AO connection
OM 1063	March 2010	Initial Release

How To Use This Manual

This manual is written for the owner and user of the Daikin VAV Controller (i.e. controller). It is designed to help you become familiar with the controller and its applications.

This section covers organization, conventions, symbols, and other information that will help utilize this owner's manual.





Manual Organization

This manual contains the following sections:

- *Product Overview* – describes the hardware components and the accessories that are used with the controller.
- *Applications and Features* – describes the available control applications that includes a terminal block for input and output connections.
- *BACnet Points List* – defines point database descriptors and includes address and applications.
- *Troubleshooting* – describes basic corrective measures to take should a problem be encountered when using the controller.
- *Glossary* – describes the terms and acronyms used in this manual.

Manual Symbols

The following table lists the symbols used in this owner's manual to draw attention to important information.

Symbol	Meaning	Description
	NOTICE	Equipment damage may occur if a procedure or instruction is not followed as specified.
	WARNING	Personal injury or property damage may occur if a procedure or instruction is not followed as specified.
	CAUTION	Minor or moderate injury may occur if a procedure or instruction is not followed as specified.
	DANGER	Electric shock, death, or severe property damage may occur if a procedure or instruction is not followed as specified.

Getting Help

Contact the Daikin Applied Controls Customer Support group at 866-462-7829 for technical assistance if necessary.

This section gives a high level overview of the Daikin VAV Controller and the applications it supports. This section will also go into a little detail regarding required/optional hardware, I/O connections, and electrical installation. More information per application can be found in [Applications and Features on page 7](#).

The controller is used in pressure independent Variable Air Volume (VAV) applications. It is an electronic-output controller that combines a damper actuator and an equipment controller into one package. It provides Direct Digital Control (DDC) for applications, and can operate independently as a stand-alone DDC room controller or networked via BACnet® MS/TP or with a field panel such as Daikin's Intelligent Systems®. The controller provides all input, output, system, and local communication connections. Hardware consists of the controller, air velocity sensor, damper actuator assembly and mounting bracket. [Table 1](#) lists available applications.

Table 1: VAV Controller Applications

Application Number	Application Description
6630	VAV Cooling Only
6631	VAV Cooling or Heating
6632	VAV with Electronic Reheat or Baseboard Radiation
6633	VAV with Hot Water Reheat
6634	VAV Series Fan Powered with Electric Reheat
6635	VAV Series Fan Powered with Hot Water Reheat
6636	VAV Parallel Fan Powered with Electric Reheat
6637	VAV Parallel Fan Powered with Hot Water Reheat
6684	Slave Mode

Figure 1: Daikin VAV Controller

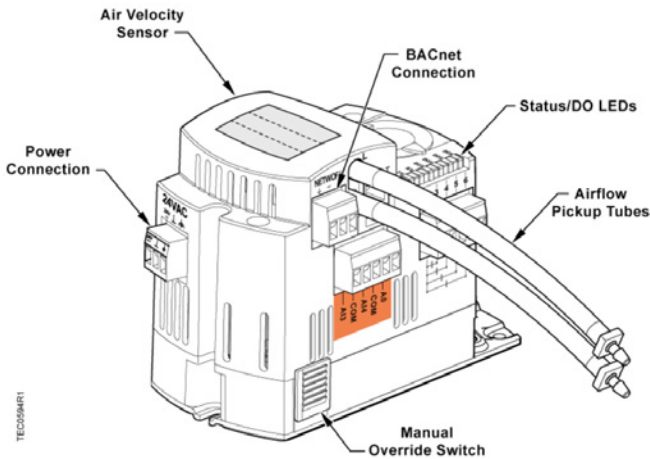

Hardware Inputs

Analog

Air Velocity Sensor			
Application 6630	Application 6631	Application 6632	Application 6633
Application 6634	Application 6635	Application 6636	Application 6637
Room Temperature Sensor			
Application 6630	Application 6631	Application 6632	Application 6633
Application 6634	Application 6635	Application 6636	Application 6637
Room Temperature Setpoint Dial (Optional)			
Application 6630	Application 6631	Application 6632	Application 6633
Application 6634	Application 6635	Application 6636	Application 6637
Room Temperature Sensor with CO ₂ Sensor (Optional)			
Application 6630	Application 6631	Application 6632	Application 6633
Application 6634	Application 6635	Application 6636	Application 6637
Room Temperature Setpoint Dial with CO ₂ Sensor (Optional)			
Application 6630	Application 6631	Application 6632	Application 6633
Application 6634	Application 6635	Application 6636	Application 6637
Duct Temperature Sensor (Optional)			
Application 6631			
One Or Two Spare Temperature Sensor (10K/100K Ω Selectable Thermistor) or Spare Digital Sensor			
Application 6630	Application 6631	Application 6632	Application 6633
Application 6634	Application 6635	Application 6636	Application 6637

Digital

Night Mode Override (Optional)			
Application 6630	Application 6631	Application 6632	Application 6633
Application 6634	Application 6635	Application 6636	Application 6637
Wall Switch (Optional)			
Application 6630	Application 6631	Application 6632	Application 6633
Application 6634	Application 6635	Application 6636	Application 6637

Hardware Outputs

Analog

Spare Analog Output (0-10 VDC)			
Application 6630	Application 6631	Application 6632	Application 6633
Application 6634	Application 6635	Application 6636	Application 6637
Valve Actuator (0-10 VDC)			
Application 6633	Application 6635	Application 6637	

Digital

Damper Actuator			
Application 6630	Application 6631	Application 6632	Application 6633
Application 6634	Application 6635	Application 6636	Application 6637
Valve Actuator (DO 3/DO 4)			
Application 6633	Application 6635	Application 6637	
2nd Valve Actuator (DO 5/DO 6)			
Application 6633			
Stage 1 Electric Heat or 2-Position Heating Valve (or Spare DO 3)			
Application 6632	Application 6634	Application 6636	
Stage 2 Electric Heat (or Spare DO 4)			
Application 6632	Application 6634	Application 6636	
Stage 3 Electric Heat (or Spare DO 5)			
Application 6632			
Spare DO 3, DO 4 or (DO 3/DO 4 Spare Floating Actuator)			
Application 6630	Application 6631		
Spare DO 5			
Application 6630	Application 6631	Application 6633	
Series Fan (DO 6)			
Application 6634	Application 6635		
Parallel Fan (DO 6)			
Application 6636	Application 6637		
Autozero Module (Optional)			
Application 6630	Application 6631	Application 6632	Application 6633
Application 6634	Application 6635	Application 6636	Application 6637

Power Wiring

The controller is powered by 24 Vac. Power wiring connects to the two screw terminals on the power connector labeled “24V” (Hot) and “⊥” (Common). The power connector connects to the 3-pin connection labeled “24VAC” with the same labels as found on the power connector (See Figure 1 to locate the power connection). The third connection is for earth ground, which is not required for operation of the controller. At a minimum, include a ground connection to the metal case of the VAV box, or other approved metal surface. Refer to Figure 2 for more information about the hot, neutral, and earth ground connections.

Figure 2: Power Wiring

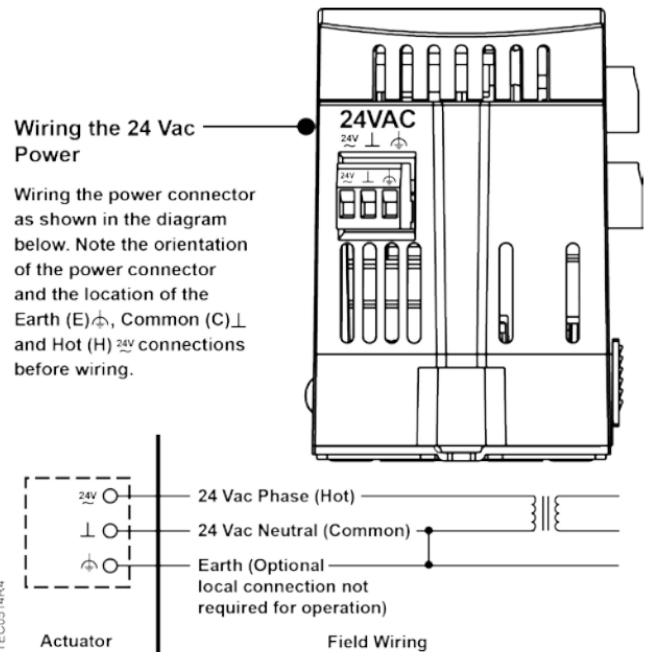

Communication Wiring

The controller communicates to a field panel (such as a Daikin Intelligent Systems controller or other network device) via BACnet MS/TP. This is done using a twisted pair wire connected to the positive (+) and negative (-) terminals as shown in Figure 3.

Figure 3: BACnet MS/TP Communication Wiring

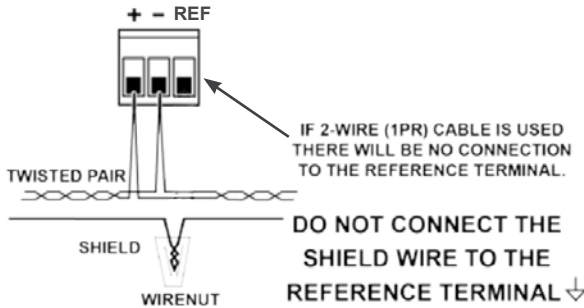

Controller LED Indicators

The controller has seven Status Light Emitting Diode (LED) indicators (see Figure 1 and Table 2).

Table 2: Controller LEDs

LED Type	Label (if present)*	LED Number	Indication
Basic Sanity Test	BST	1	Indicates, when flashing ON and OFF once per second, that the controller is functioning properly.
Transmit	TX	2	Indicates, when flashing, that the controller is transmitting information to the field panel.
Receive	RX	3	Indicates, when flashing, that the controller is receiving information from the field panel.
DO	LED 3-LED 6	4-7	Indicates the ON/OFF status of the DO associated with it. A glowing LED indicates that the DO is energized.

* Some LED labels and numerals may be hidden by the controller cover.

Temperature Sensors

Room Temperature Sensor

The room temperature sensor connects to the controller by means of a cable terminated at both ends with a six-conductor RJ-11 plug-in connector.

Room Temperature Sensor with CO₂

Room temperature sensors are also available with an optional CO₂ sensor. Regardless if it is just a sensor, or a sensor with a setpoint dial, the CO₂ sensor requires more power than the RJ-11 alone can deliver from the controller. When this configuration is selected, an additional power module with a short RJ-11 cable will be included. Please refer to [IM 1261](#) for more detailed installation instructions for the power module.

Duct Temperature Sensor

An optional duct temperature sensor provides duct air temperature sensing inputs to the controller. For more information about temperature sensors, contact your local Daikin representative.

Related Equipment

- Relay Module
- Damper Actuator(s)
- Duct Temperature Sensor (Optional)
- Room Temperature Sensor [with or without setpoint dial] (Optional)
- Room Temperature Sensor with CO₂ Sensor [with or without setpoint dial] (Optional)

Contact your local Daikin representative for product numbers and more information.

This section outlines the features and applications supported by the Daikin VAV controller.

The controller provides Direct Digital Control (DDC) for Variable Air Volume (VAV) terminal box applications. If heating is included, it can be provided by hot water, up to three stages of electric reheat, or baseboard radiation though temperature control varies with the application. This section is split into an overview of features inherent to the controller (Occupancy, Control Loops, Calibration, Self-Regulation, and Fault Detection and Diagnostics) and also descriptions of each individual application the controller supports.

NOTE: Some of the features require additional hardware or hardware specific to certain applications.

Occupancy

Day/Night Mode

The controller maintains the specified day setpoint temperature during daytime hours and the specified night setpoint during nighttime hours.

Occupancy (Night Mode) Override Switch

If the room temperature sensor has an override switch (i.e. it has a setpoint dial), it can be used to command the controller into day mode for an adjustable period of time. This can only affect an unoccupied controller (a controller in night mode).

Control Loops

Temperature Loop (Heating or Cooling)

The controller maintains the temperature setpoint in day or night mode by changing the flow setpoint or modulating the heat source (hot water valve or electric reheat) if available to the controller.

Heating and Cooling Switchover

The heating/cooling switchover determines whether the controller is in heating or cooling mode by monitoring the room temperature and the demand for heating and cooling.

Control Temperature Setpoints

The controller maintains a specified temperature setpoint based on Day/Night mode, the heating/cooling mode, or the setpoint dial (if present).

Flow Loop

The controller maintains the flow setpoint by modulating the damper actuator position.

Modulate Damper during Heating Mode (optional)

CAUTION

If the damper is set to modulate in heating mode, make sure the controller is in the appropriate mode for the current supply air temperature.

Applications that have a heating source (hot water or electric) can be configured to modulate the flow setpoint in sequence with the heating source.

Hot Water Reheat

CAUTION

Do not set HTG FLOW MIN to 0 cfm (0 lps). A minimum airflow should be provided across the heating coils when the heating valve is open.

The heating loop modulates the heating valve(s) to warm up the room. In cooling mode, the heating valve is closed.

Electric Reheat

CAUTION

Verify that the equipment is supplied with "Safeties by Others"¹ to ensure that there is airflow across the heating coils when they are to be energized.

The heating loop controls up to three stages of electric reheat to warm up the room. The electric reheat is time modulated using a duty cycle. When the controller is in cooling mode, the electric heat is OFF at all times.

¹ "Safeties by Others" implies that the associated equipment has safety features installed. An example is adding mechanical stops to the dampers.

Calibration

Air Velocity Sensor

Calibration of the controller's internal air velocity sensor is periodically required to maintain accurate air velocity readings. Calibration may be set to take place automatically or manually.

Autozero Module (AZM)

An AZM is used when damper cannot be closed and constant airflow is needed.

For a controller used with an AZM, calibration occurs without closing the damper (see applications 6630, 6631, 6632, and 6633).

For a controller without an AZM, the damper is briefly commanded closed to get a zero airflow reading and an accurate damper position during calibration (see applications 6630, 6631, 6632, and 6633).

Hot Water Valve

Calibration of a hot water valve is done by briefly commanding the valve closed (see applications 6633, 6635, and 6637).

Controller Self-Regulation and Maintenance

Floating Control Actuation Auto-correct

In addition to the existing options for floating control actuator full stroke actions, all floating control actuators are provided with additional logic to fully drive open or closed when commanded to 100% or 0%.

Fail-safe Operation

If the air velocity sensor fails, the controller uses pressure dependent control. The temperature loop controls the operation of the damper. If the room temperature sensor fails, then the controller operates using the last known temperature value.

Automated Fault Detection and Diagnostics (Checkout)

The controller has a built-in checkout procedure that performs a basic fault detection and diagnostic routine. It can be manually initiated at any time after the controller has been installed. This procedure tests all of the necessary I/O and ensures the controller can operate within the set airflow range, between CLG FLOW MIN and CLG FLOW MAX.

To perform the checkout procedure, set CHK OUT to YES. When the procedure has completed, CHK OUT returns to NO and the results display in CHK STATUS. See Table 2 for the description associated with each value of CHK STATUS in [Troubleshooting on page 21](#)

NOTE: In order to perform anything in this section, a WCIS Cable (or RJ-11 to Serial cable, P/N: 250804701) is required in order to connect a laptop running the WCIS software to the controller. Contact a Daikin Representative for more information.

Application 6630 VAV Cooling Only

Overview

In Application 6630, the controller modulates the supply air damper of the terminal box for cooling. In order for it to work properly, the central air-handling unit must provide cool supply air. See [Figure 4](#)

Figure 4: Application 6630 Schematic

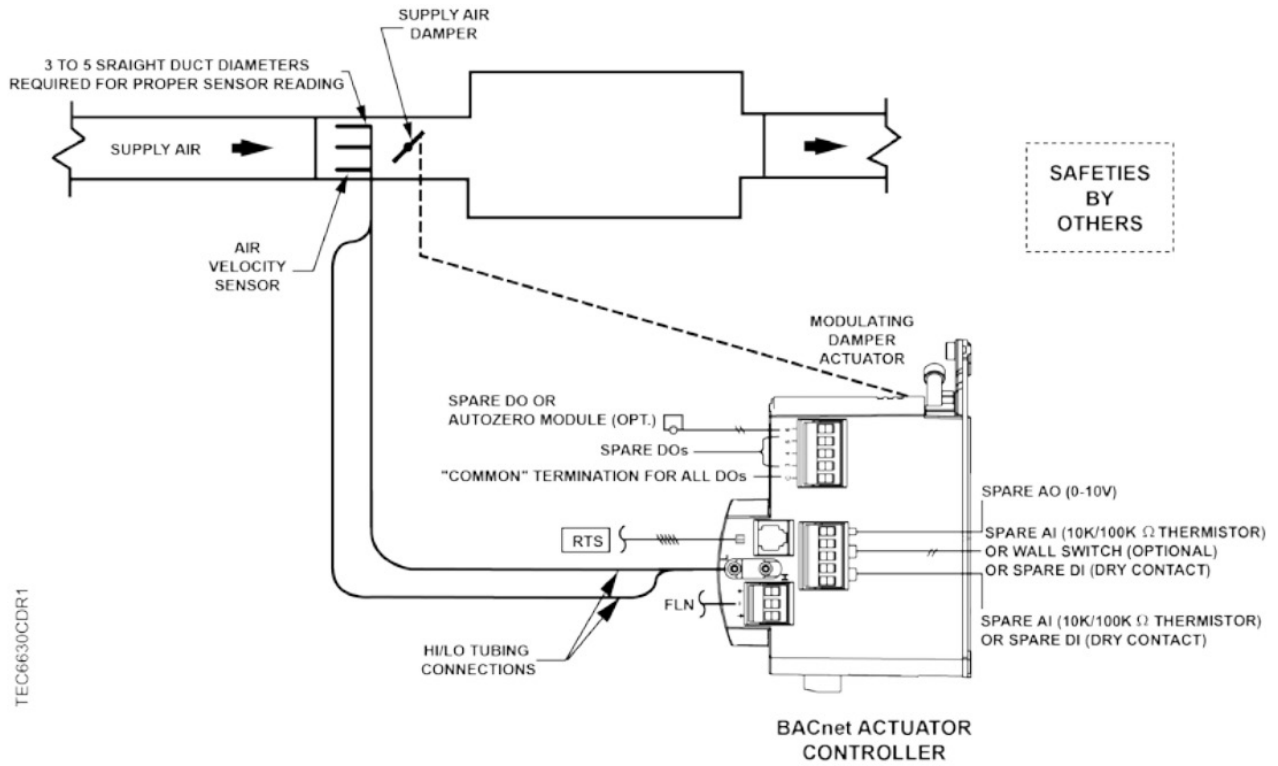

Application 6631 VAV Cooling or Heating

Overview

In Application 6631, the controller modulates the supply air damper of the terminal box for cooling or heating. In order for it to work properly, the central air-handling unit must provide cool supply air in cooling mode and warm air during heating mode. See Figure 5.

Figure 5: Application 6631 Schematic

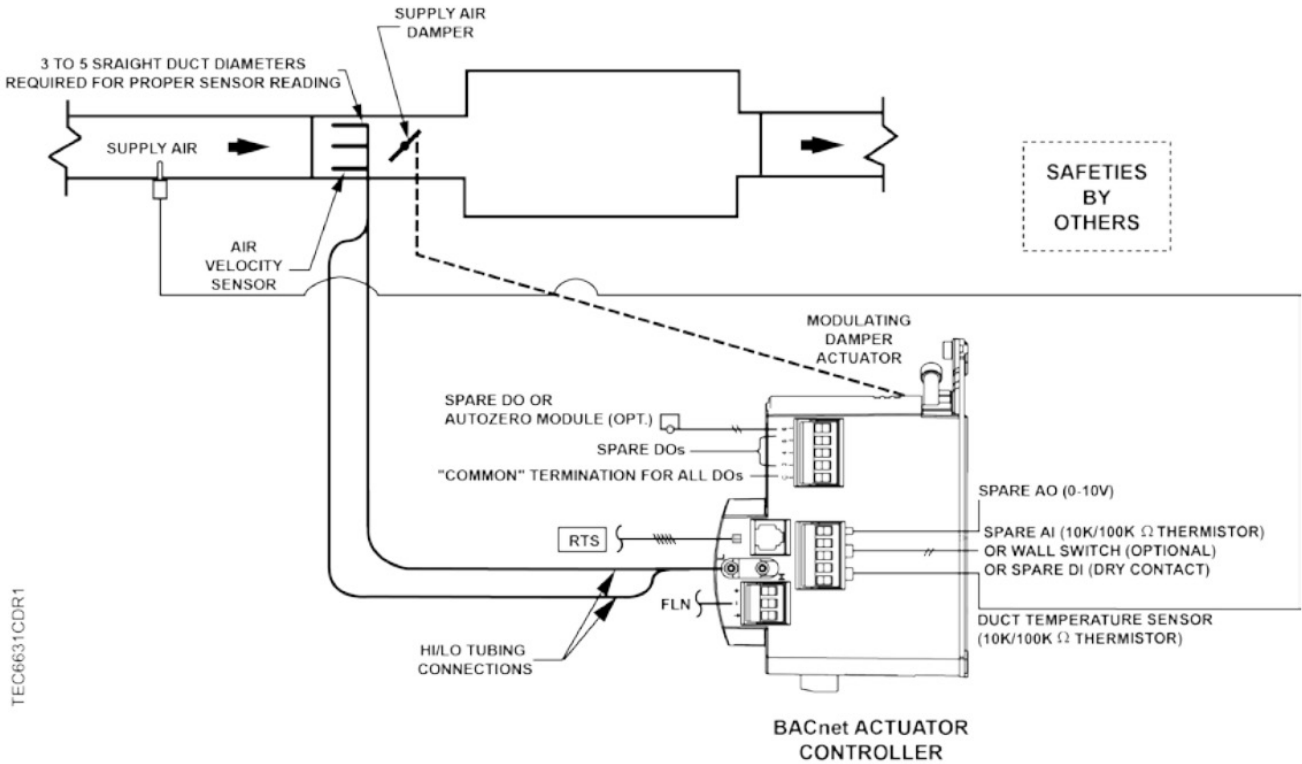

Application 6632 VAV with Electric Reheat or Baseboard Radiation

Overview

In Application 6632, the controller modulates the supply air damper of the terminal box for cooling and controls stages of electric reheat or baseboard radiation for heating. When in heating, the terminal box either maintains minimum airflow or modulates the supply air damper. In order for the terminal box to work properly, the central air-handling unit must provide supply air. See [Figure 6](#) and [Figure 7](#).

Electric Heat Interlock

CAUTION
Do not set EHEAT FLOW (the defined minimum) to less than 5%; otherwise, the electric heat interlock will be disabled.

The electric heat stages are disabled (turned OFF) when the electric heat airflow is less than the defined minimum.

Baseboard Radiation

Baseboard radiation can be a two-position valve or electrical resistance heating.

If the controller is in cooling mode, the heating valve is closed. When in heating mode, the controller operates the heating valve to maintain the heating setpoint.

Figure 6: Application 6632 Schematic (Electric Heat)

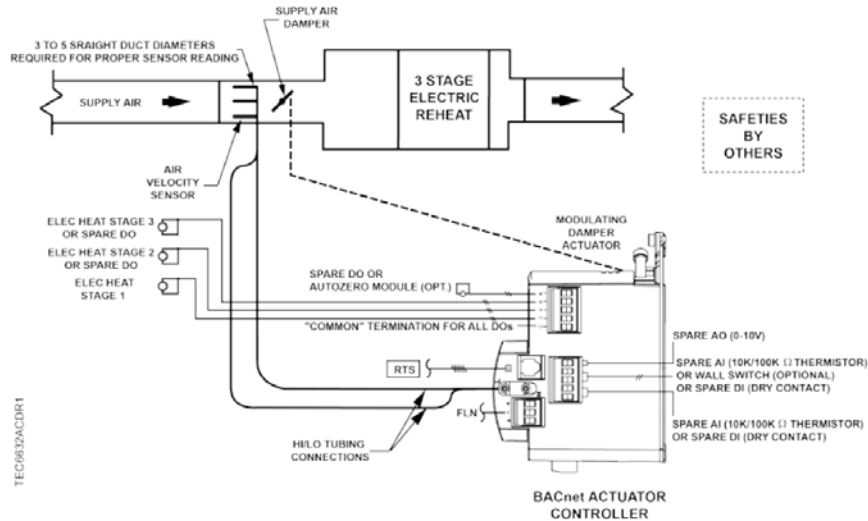
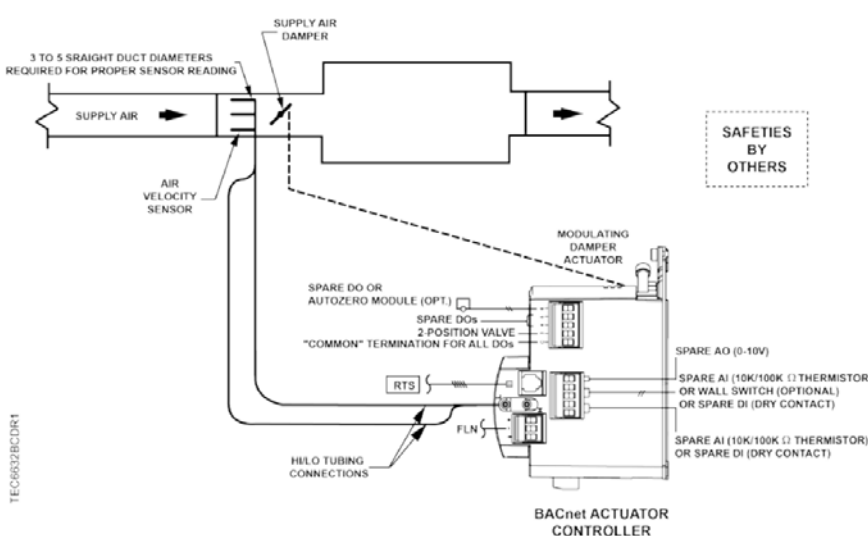

Figure 7: Application 6632 Schematic (Baseboard Radiation)



Application 6633 VAV with Hot Water Reheat

Overview

In Application 6633, the controller modulates the supply air damper of the terminal box for cooling and controls a hot water valve (or valves) for heating. When in heating, the terminal box either maintains minimum airflow or modulates the supply air damper. In order for the terminal box to work properly, the central air-handling unit must provide supply air for cooling. See Figure 8 and Figure 9.

Figure 8: Application 6633 Schematic (HW Heat and Spare DO)

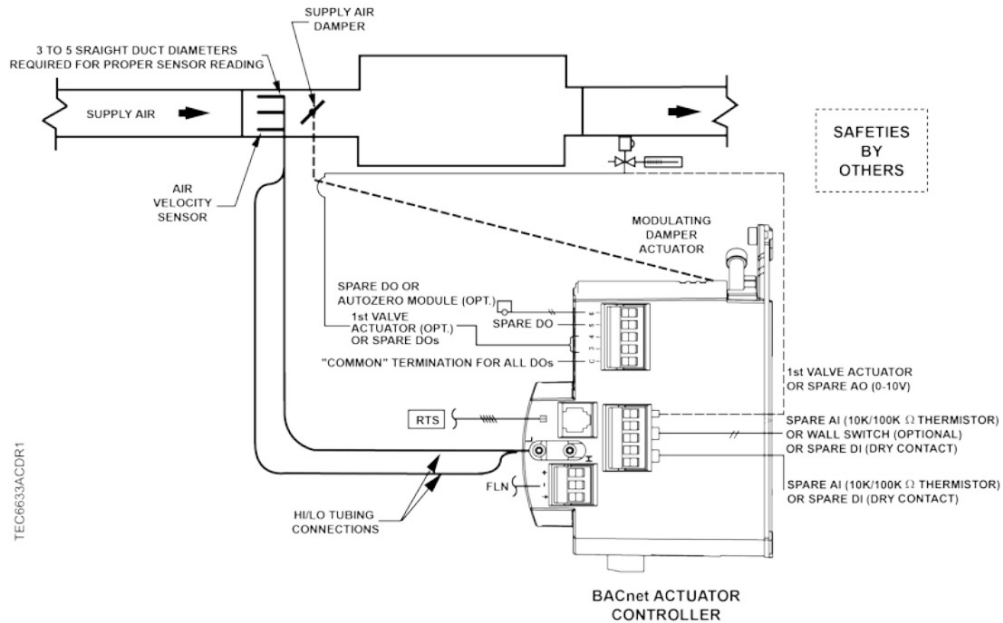
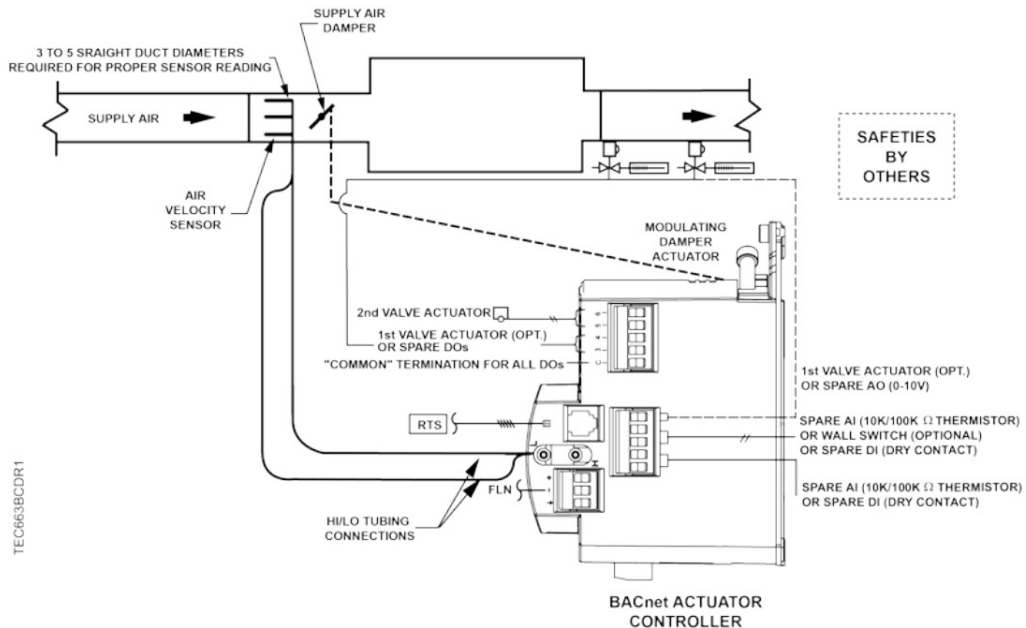

Figure 9: Application 6633 Schematic (Two Valve Actuators)



Application 6635 and 6637 VAV Series Fan or Parallel Fan and Hot Water Reheat

Overview

In Application 6635, the controller modulates the supply air damper of the terminal box for cooling and modulates a hot water valve for heating. When in heating, the terminal box either maintains minimum airflow or modulates the supply air damper. Application 6637 has a parallel fan that re-circulates the room air. In order for the terminal box to work properly, the central air-handling unit must provide supply air. See Figure 12 and Figure 13.

Fan Operation

CAUTION

On series fan powered terminal boxes, the terminal box fan must be controlled/interlocked to start either before or at the same time as the central air handler. Failure to do so may cause the terminal box fan to rotate backwards and cause consequent damage at start up.

In day mode, the fan is ON all the time. In night mode, the fan cycles on when heating or cooling is required.

Figure 12: Application 6635 Schematic

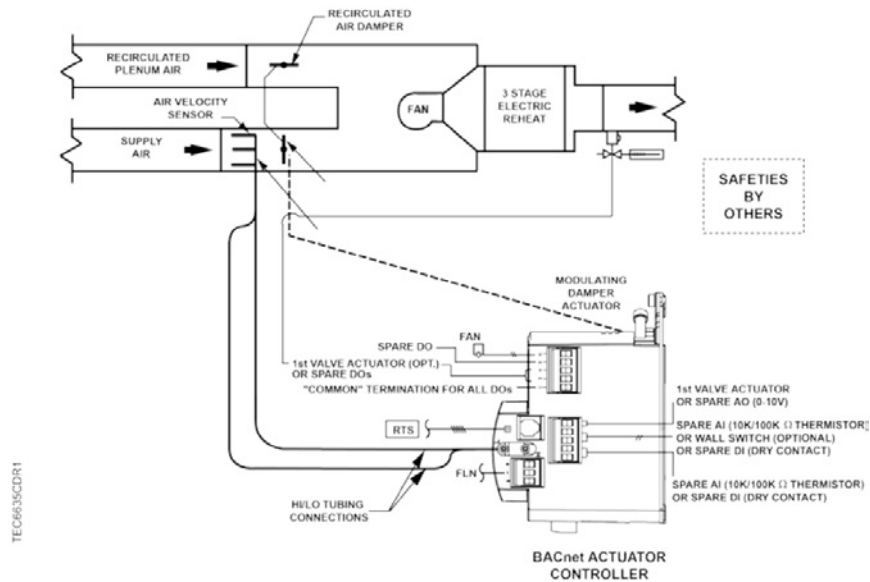
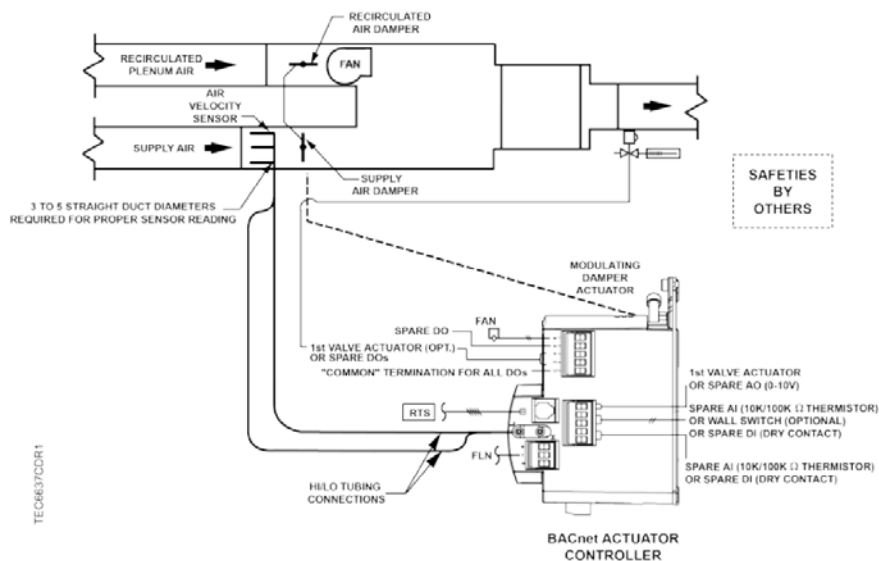

Figure 13: Application 6637 Schematic.



Application 6684 Slave Mode

Overview

Application 6684 is the slave mode application for the controller. Slave mode is the default application that comes up when power is first applied to the controller. Slave mode provides no control. Its purpose is to allow the operator to perform equipment checkout before a control application is put into effect and to set some basic controller parameters (CTRL ADDRESS, APPLICATION, etc.). A controller in default state can also be used as a point extension device by unbundling spare I/O points at the field panel.

Using Auxiliary Points

It is possible to have extra points available on a controller — Electronic Output in addition to the ones used by the current application that is running in the controller. If these extra points are to be controlled by a field panel, then they must be unbundled at the field panel.

Using the Controller as a Point Extension Device

If the controller is only used as a point extension device, with no control application in effect, its application must be set to slave mode and points must be unbundled at the field panel. All points must be controlled from the field panel in order to be used.

DO 3, DO 4, DO 5, and DO 6 may be used separately or in pairs (DO 3 and DO 4, DO 5 and DO 6) to control a motor as shown in the example.

NOTE: If using either a motor or DOs as auxiliary points, it is important to set MTR SETUP to the correct value. If using a pair of DOs to control a motor, then the DOs cannot be unbundled. Only MTR1 COMD and MTR2 COMD can be unbundled to control the motors.

Example

If using DO 1 and DO 2 as the physical terminations for a motor, follow these steps:

1. Set MTR SETUP to 1 to enable the motor.
2. Unbundle MTR1 COMD at the field panel to command the motor from the field panel.

Contact your local Daikin representative for other combinations of DOs and motors.

Overview

This section provides information about the BACnet MS/TP points available in the controller database. These points support connection to a field panel such as a Daikin Intelligent Systems® controller or other network device.

A description of each point in the database, including network address and pertinent applications, is summarized in [Table 3](#).

Table 3: BACnet Point List with Descriptions and Applications

Descriptor	Address ¹	Application	Description
CTLR ADDRESS	01	All	Identifies the controller on the communications trunk.
APPLICATION	02	All	Identification number of the program running in the controller.
RMTMP OFFSET	03	All	Compensates for deviations between the value of ROOM TEMP and the actual room temperature. This corrected value is displayed in CTL TEMP. RMTMP OFFSET + ROOM TEMP = CTL TEMP
ROOM TEMP	{04} ²	All	Actual reading from the room temperature sensor.
HEAT.COOL	{05}	All except 6630, 6684	Current mode of operation for applications that can be in either a heating mode or a cooling mode.
DAY CLG STPT	06	All except 6684	The temperature setpoint in degrees that the controller maintains during day periods in cooling mode if a room temperature sensor setpoint dial is not present or is not used. See STPT DIAL.
DAY HTG STPT	07	All except 6630, 6684	The temperature setpoint in degrees that the controller maintains during day periods in heating mode if a room temperature sensor setpoint dial is not present or is not used. See STPT DIAL.
NGT CLG STPT	08	All except 6684	The temperature setpoint in degrees that the controller maintains during the night periods in cooling mode.
NGT HTG STPT	09	All except 6630, 6684	The temperature setpoint in degrees that the controller maintains during the night periods in heating mode.
DEW POINT	{10}	All except 6684	Dew point temperature calculation using room temperature (CTL TEMP) and room humidity (RM RH).
RM STPT MIN	11	All except 6684	The minimum temperature setpoint in degrees that the controller can use from the setpoint dial. This overrides any temperature setpoint from the setpoint dial that falls below this minimum.
RM STPT MAX	12	All except 6684	The maximum temperature setpoint in degrees that the controller can use from the setpoint dial. This overrides any temperature setpoint from the setpoint dial that falls above this maximum.
RM STPT DIAL	{13}	All	The temperature setpoint in degrees from the room temperature sensor (not available on all temperature sensor models). This setpoint will be used for control in day mode (heating or cooling) when enabled by STPT DIAL.
STPT DIAL	14	All except 6684	YES indicates that there is a room setpoint dial on the room temperature sensor and it should be used as the temperature setpoint for control in day/occupied mode. NO indicates that the appropriate preset setpoint will be used as the temperature setpoint for control in day/occupied heating or cooling mode. Valid input: YES or NO.
AUX TEMP AI 3	{15}	All except 6631	Actual reading from a 10K Ω thermistor connected to the controller's AI 3 input. When a thermistor is connected at AI 3, DI 3 is not available. See DI 3.
SUPPLY TEMP	{15}	6631	Actual reading from a 10K Ω thermistor connected to the controller's AI 3 input. The controller uses this value to determine whether it is in heating or cooling mode.
FLOW START	16	All except 6630, 6631, 6684	Determines how the damper modulation will be sequenced while in heating mode. When HTG LOOPOUT is above this value, then FLOW STPT starts to increase.
FLOW END	17	All except 6630, 6631, 6684	Determines how the damper modulation will be sequenced while in heating mode. When HTG LOOPOUT is below this value, then FLOW STPT starts to decrease.
WALL SWITCH	18	All	YES indicates that the controller is to monitor the status of a wall switch that is connected to DI 2. NO indicates that the controller will not monitor the status of a wall switch, even if one is connected. Valid input: YES or NO.
DI OVRD SW	{19}	All	Actual indication of the status of the override switch (not physically available on all temperature sensor models) at the room temperature sensor. ON indicates that the switch is being pressed. OFF indicates that the switch is released. Valid input: ON or OFF.
OVRD TIME	20	All except 6684	The amount of time in hours that the controller will operate in day/occupied mode when the override switch is pressed while the controller is in night/unoccupied mode.

1. Points not listed are not used in this application.

2. Point numbers that appear in brackets { } may be unbundled at the field panel.

Descriptor	Address ¹	Application	Description
NGT OVRD	{21} ²	All except 6684	Indicates the mode that the controller is operating in with respect to the override switch. NIGHT indicates that the switch has not been pressed and the override timer is not active. DAY indicates that the switch has been pressed and the override timer is active. The controller then uses a day mode temperature setpoint. This point is only in effect when DAY. NGT indicates night mode.
REHEAT START	22	All except 6630, 6631, 6684	Determines how the reheat modulation will be sequenced while in heating mode. When HTG LOOPOUT is above this value, then the reheat modulates upward.
REHEAT END	23	All except 6630, 6631, 6684	Determines how the reheat modulation will be sequenced while in heating mode. When HTG LOOPOUT is below this value, then the reheat modulates downward.
DI 4	{24}	All	Actual status of a contact connected to the controller at DI 4. ON indicates that the contact is closed; OFF indicates that the contact is open. If a wall switch is used, it is connected to DI 4. See WALL SWITCH.
DI 3	{25}	All	Actual status of a contact connected to the controller at AI 3/DI 3. ON indicates that the contact is closed; OFF indicates that the contact is open. When a contact is connected at DI 3, AI 3 is not available. See AUX TEMP AI 3.
SERIES ON	26	6634, 6535	When flow rises above this value, the series fan will turn ON.
SERIES ON	26	6636	This point is present, but not used in this application.
SERIES OFF	27	6634, 6535	When flow drops below this value and other conditions have been met, the series fan will turn OFF.
SERIES OFF	27	6636	This point is present, but not used in this application.
PARALLEL ON	28	6636, 6637	When flow drops below this value and other conditions have been met, the parallel fan will turn ON.
PARALLEL ON	28	6634	This point is present, but not used in this application.
DAY.NGT	{29}	All	Indicates the mode in which the controller is operating. Day temperature setpoints will be used in day mode. Night temperature setpoints will be used in night mode. This point is normally set by the field panel.
PARALLEL OFF	30	6636, 6637	When flow rises above this value, the parallel fan will turn OFF.
PARALLEL OFF	30	6634	This point is present, but not used in this application.
CLG FLOW MIN	31	All except 6684	The minimum amount of air in CFM (LPS) to be supplied to the space in cooling mode.
CLG FLOW MAX	32	All except 6684	The maximum amount of air in CFM (LPS) to be supplied to the space in cooling mode.
HTG FLOW MIN	33	All except 6630, 6684	The minimum amount of air in CFM (LPS) to be supplied to the space in heating mode.
HTG FLOW MAX	34	All except 6630, 6684	The maximum amount of air in CFM (LPS) to be supplied to the space in heating mode.
AIR VOLUME	{35}	All	Actual amount of air in CFM (LPS) currently passing through the air velocity sensor.
FLOW COEFF	36	All	Calibration factor for the airflow sensor.
MTR3 COMD	{37}	6630, 6631, 6632, 6684	The value to which the Motor 3 actuator is commanded in percent of full value.
VLV2 COMD	{37}	6633	The value to which the valve 2 actuator is commanded in percent of full travel for applications using a second water valve.
MTR3 POS	{38}	6630, 6631, 6632, 6684	The current position of the Motor 3 actuator in percent of full travel. This value is calculated based on motor run time.
VLV2 POS	{38}	6633	The current position of Valve 2 in percent of full travel. This value is calculated based on valve run time.
MTR3 TIMING	39	All except 6634, 6635, 6636, 6637	The time required for the Motor 3 actuator to travel from the full closed position to the full open position.
NGT FLOW MIN	40	All except 6684	Optional air flow setpoint to be used for CTL FLOW MIN in NIGHT mode.
DO 1	{41}	All	Digital output 1 controls a 24 VAC load with an ON or OFF status. If Motor 1 is enabled, DO 1 is coupled with DO 2 to control an actuator.
DO 2	{42}	All	Digital output 2 controls a 24 VAC load with an ON or OFF status. If Motor 1 is enabled, DO 2 is coupled with DO 1 to control an actuator.
DO 3	{43}	All except 6632, 6634, 6636	Digital output 3 controls a 24 VAC load with an ON or OFF status. If Motor 2 is enabled, DO 3 is coupled with DO 4 to control an actuator.
HEAT STAGE 1	{43}	6632, 6634, 6636	This point is DO 3 in applications with electric reheat. This digital output controls the contact for the first stage of heating and has a status of ON or OFF.
DO 4	{44}	All except 6632, 6634, 6636	Digital output 4 controls a 24 VAC load with an ON or OFF status. If Motor 2 is enabled, DO 4 is coupled with DO 3 to control an actuator.
HEAT STAGE 2	{44}	6632, 6634, 6636	This point is DO 4 in applications with electric reheat. This digital output controls the contact for the second stage of heating and has a status of ON or OFF.
DO 5	{45}	6630, 6631, 6633, 6684	Digital output 5 controls a 24 VAC load with an ON or OFF status. If Motor 3 is enabled, DO 5 is coupled with DO 6 to control an actuator.
DO 5	{45}	6636, 6637	Digital output 5 controls a 24 VAC load with an ON or OFF status.
HEAT STAGE 3	{45}	6632, 6634, 6636	This point is a digital output used to control the contact for the third stage of heating and has a status of ON or OFF.

1. Points not listed are not used in this application.

2. Point numbers that appear in brackets { } may be unbundled at the field panel.

Descriptor	Address ¹	Application	Description
DO 6	{46} ²	All except 6634, 6635, 6636, 6637	Digital output 6 controls a 24 VAC load with an ON or OFF status. If Motor 3 is enabled, DO 6 is coupled with DO 5 to control an actuator. In applications with CAL MODULE set to YES, this digital output controls the Autozero Module to calibrate the controller's internal air velocity transducer.
FAN	{46}	6634, 6635, 6636, 6637	This point is a digital output used to control the fan. ON indicates that the DO is energized; OFF indicates that the DO is de-energized.
VENT DMD MIN	{47}	All except 6684	Optional air flow setpoint (command-able) to be used with the larger of CLG FLOW MIN in cooling or HTG FLOW MIN in heating for CTL FLOW MIN in DAY mode.
DMPR COMD	{48}	All except 6684	The value to which the damper motor is commanded in percent of full travel.
MTR1 COMD	{48}	6684	The value to which the Motor 1 actuator is commanded in percent of full travel.
DMPR POS	{49}	All except 6684	The current position of the damper motor in percent of full travel. This value is calculated based on motor run time.
MTR1 POS	{49}	6684	The current position of Motor 1 in percent of full travel. This value is calculated based on motor run time. See MTR1 TIMING.
AI 4	{50}	All	Actual reading from a 10K or 100K Ω thermistor connected to the controller's AI 4 input (long board). When a sensor is connected at AI 4, DI 4 is not available.
MTR1 TIMING	51	All	The time required for the Motor 1 actuator to travel from full closed to the full open position.
MTR2 COMD	{52}	6630, 6631, 6684	The value to which the Motor 2 actuator is commanded in percent of full travel (for use as an auxiliary slave point).
VLV COMD	{52}	6636, 6637	The value to which the valve actuator is commanded in percent of full travel for applications using a water valve.
VLV1 COMD	{52}	6633	The value to which the valve 1 actuator is commanded in percent of full travel for applications using a water valve.
MTR2 POS	{53}	6630, 6631, 6684	The current position of the Motor 2 actuator in percent of full travel (for use as an auxiliary slave point). This value is calculated based on motor run time. See MTR2 TIMING.
VLV POS	{53}	6635, 6637	The current position of the valve in percent of full travel for applications using a water valve. This value is calculated based on motor run time.
VLV1 POS	{53}	6633	The current position of valve 1 in percent of full travel for applications using a water valve. This value is calculated based on motor run time.
STPT SPAN	54	6631, 6632, 6634, 6636	The configuration value for room units to function in warmer/cooler adjustments. A value of 0 allows room units to function in standard/absolute temperature setpoint mode.
MTR2 TIMING	55	All except 6632, 6634, 6636	The time required for the Motor 2 actuator to travel from full closed to the full open position.
DMPR ROT ANG	56	All except 6684	The number of degrees the damper is free to travel.
DPR1 ROT ANG	56	6684	The number of degrees that damper 1 is free to travel.
DPR2 ROT ANG	57	6684	The number of degrees that damper 2, the hot duct damper, is free to travel.
MTR SETUP	58	All	The configuration setup code for Motors 1 and 2. This enables the motors individually and sets each motor to be either direct or reverse acting. NOTE: When a motor is enabled, its associated DOs are enabled.
DO DIR.REV	59	All	The configuration setup code for DOs. Allows the DOs to be direct or reverse acting (enabled equals energized or disabled equals de-energized).
EHEAT FLOW	60	6632	The flow required before the electric heat will be enabled.
COOL TEMP	61	6631	The discharge air temperature where the controller will switch from heating to cooling mode. Used only in applications with SUPPLY TEMP (15).
HEAT TEMP	62	6631	The discharge air temperature where the controller will switch from cooling to heating mode. Used only in applications with SUPPLY TEMP (15).
CLG P GAIN	63	All except 6684	The proportional gain value for the cooling temperature control loop.
CLG I GAIN	64	All except 6684	The integral gain value for the cooling temperature control loop.
CLG D GAIN	65	All except 6684	The derivative gain value for the cooling temperature control loop.
CHK OUT	{66}	All	The procedure tests all of the necessary I/O and ensures the controller has the ability to operate within the set airflow range, between CLG FLOW MIN and CLG FLOW MAX.
HTG P GAIN	67	All except 6630, 6684	The proportional gain value for the heating temperature control loop.
HTG I GAIN	68	All except 6630, 6684	The integral gain value for the heating temperature control loop.
HTG D GAIN	69	All except 6630, 6684	The derivative gain value for the heating temperature control loop.
CHK STATUS	{70}	All	Displays the results of CHK OUT.
FLOW P GAIN	71	All except 6684	The proportional gain value for the flow control loop.
FLOW I GAIN	72	All except 6684	The integral gain value for the flow control loop.
FLOW D GAIN	73	All except 6684	The derivative gain value for the flow control loop.
FLOW BIAS	74	All except 6684	The biasing of the flow control loop.
FLOW	{75}	All except 6684	Indicates the amount of air currently passing the air velocity sensor. The value is calculated as a percentage based on where the value of AIR VOLUME is in the range between 0 and CTL FLOW MAX.

1. Points not listed are not used in this application.

2. Point numbers that appear in brackets { } may be unbundled at the field panel.

Descriptor	Address ¹	Application	Description
CTL FLOW MIN	{76} ²	All except 6684	The active minimum flow used as a limit for the flow control loop. This value is the same as CLG FLOW MIN if the controller is in cooling mode, or is the same as HTG FLOW MIN if the controller is in heating mode, unless it is overridden.
CTL FLOW MAX	{77}	All except 6684	The active maximum flow used as a limit for the flow control loop. This value is the same as CLG FLOW MAX if the controller is in cooling mode, or is the same as HTG FLOW MAX if the controller is in heating mode unless, it is overridden.
CTL TEMP	{78}	All except 6684	The temperature used as input for the temperature control loops. This value is the same as the value in ROOM TEMP and RM TEMP OFFSET unless it is overridden.
CLG LOOPOUT	{79}	All except 6684	The cooling temperature control loop output value in percent.
HTG LOOPOUT	{80}	All except 6630, 6684	The heating temperature control loop output value in percent.
AVG HEAT OUT	{81}	6632, 6634, 6636	This point is used to determine what stages of electric heat are used for a given loop output value. The ranges for the value are determined by the number of stages used: 0 to 100 for 1 stage of electric heat, 0 to 200 for 2 stages of electric heat, and 0 to 300 for 3 stages of electric heat. With electric heat, this value is equal to: HTG LOOPOUT × STAGE COUNT.
STAGE MAX	82	6632, 6634, 6636	The value, in percent, which the heating loop must exceed for the electric heat to be ON for the full duty cycle (STAGE TIME).
STAGE FAN	83	6636, 6637	The valve must be opened greater than this value before the fan will turn ON.
STAGE MIN	83	6632, 6634, 6636	The value, in percent, which the heating loop must go below for the electric heat to be OFF for the full duty cycle (STAGE TIME).
AOV 1	{84}	All	(Optional) Analog output (0-10 VDC). May be used to control a water valve (6633, 6635, 6637) by setting Motor 2 in MTR SETUP to "Not Configured." This disables the corresponding DO control.
SWITCH LIMIT	85	All except 6630, 6631, 6684	The active temperature control loop output must be less than this value to switch between cooling mode and heating mode. Actual switchover depends on SWITCH DBAND being exceeded and is subject to SWITCH TIME being expired.
SWITCH TIME	86	All except 6630, 6631, 6684	The time, in minutes, before the heat/cool mode can change over when the other parameters are appropriate.
CAL MODULE	87	All except 6634, 6635, 6636, 6637	YES indicates that the Autozero Modules are enabled to calibrate the air velocity transducers. The dampers will not be used for calibration. NO indicates that Autozero Modules are disabled and that the air velocity transducers will be calibrated by closing the dampers. Valid input: YES or NO.
STAGE COUNT	88	6632, 6634, 6636	The number of electric heating stages used by the application. DOs associated with unused stages may be used as spare DOs.
VALVE COUNT	88	6633	The number of heating valves available.
STAGE TIME	89	6632, 6634, 6636	The cycle time in minutes for the electric reheat stages. For example, if there are three stages of electric heat and STAGE TIME = 10 minutes, STAGE COUNT = 3, and AVG HEAT OUT = 150% then, Stage 1 is ON for 10 minutes (100% of the time), Stage 2 is ON for 5 minutes (50% of 10 minutes) and OFF for 5 minutes, and Stage 3 is OFF.
SWITCH DBAND	90	All except 6630, 6631, 6684	The temperature range in degrees which is compared to the difference between CTL TEMP and CTL STPT. The difference must exceed this value for temperature control mode to change over. Changeover is also subject to the active temperature control loop output being below SWITCH LIMIT and SWITCH TIME being expired.
CTL STPT	{92}	All except 6684	The actual setpoint value being used as input for the active temperature control loop.
FLOW STPT	{93}	All except 6684	The setpoint of the flow control loop.
CAL AIR	{94}	All	YES commands the controller to go through calibration sequence for the air velocity transducers. YES is also displayed when the calibration sequence is started automatically. CAL AIR automatically returns to NO after the calibration sequence is completed. Valid input: YES or NO.
CAL SETUP	95	All	The configuration setup code for the calibration sequence options.
CAL TIMER	96	All	Time interval, in hours, between the calibration sequence initiations if a timed calibration option is selected in CAL SETUP.
DUCT AREA	97	All	Area, in square feet (square meters), of the duct where the air velocity sensor is located. This is a calculated value (calculated by the field panel or computer being used) that depends on duct shape and size. It is used in calculating all points in units of CFM, CF, LPS and L. Valid input: .025 ft ² (.002 m ²) through 6.375 ft ² (.5923 m ²).
LOOP TIME	98	All except 6684	The time, in seconds, between control loop calculations.
ERROR STATUS	{99}	All	The status code indicating any errors detected during controller power up. A status of 0 indicates there are no problems.
AOV 1 CLOSE	102	6633, 6635, 6637	The voltage output from the AO that commands the water valve to close. Valid input: 0 through 10.23 Volts
AOV 1 OPEN	103	6633, 6635, 6637	The voltage output from the AO that commands the water valve to open. Valid input: 0 through 10.23 Volts
SENSOR SEL	124	All	Room unit configuration point and thermistor type selection, values are additive.

1. Points not listed are not used in this application.

2. Point numbers that appear in brackets { } may be unbundled at the field panel.

Descriptor	Address ¹	Application	Description
RM CO ₂	{125} ²	All	This point may be used in a control strategy as occupancy increases (CO ₂ levels increase) in the room being controlled.
RM RH	{126}	All	Room humidity when room unit is provided with humidity sensing.
PPCL STATE	{127}	All	This point is an indicator that customized programming has been added in addition to the normal control strategy of the application being used. This point is read as LOADED or EMPTY. A status of LOADED indicates that there is PPCL programming in the controller, and it is providing unique control to meet a customer's job specification. A status of EMPTY indicates that no unique programming is present.

1. Points not listed are not used in this application.

2. Point numbers that appear in brackets { } may be unbundled at the field panel.

This section describes corrective measures you can take should you encounter an issue when using a Daikin VAV Controller.

When troubleshooting, record specific symptoms and what actions were performed immediately before the problem occurred. Being able to describe the problem in detail is important should you need assistance from your local Daikin representative.

DANGER

Before beginning any service or maintenance, disconnect the main power to the controller. Failure to do so can cause electrical shock resulting in property damage, personal injury or death.

Basic Service Information

Always remove power to the controller when installing or replacing it. The controller does not have a power switch. A different method of removing power is necessary depending on how power is connected for the application. For instance, on a locally powered controller, it is recommended that you turn off power by removing power to the 24 Vac transformer. *However, on a controller powered by a power cable (even if it's a single controller) remove power either at the local disconnect or unplug the 24-volt power from the VAV actuator itself.*

NOTE: When removing power to a controller to perform maintenance or service, confirm that the facility manager is aware of this and that appropriate steps are taken to keep the building in control while it is being serviced.

Never remove the cover from the controller. There are no serviceable parts inside. An anti-static wrist strap is recommended when installing or replacing a controller.

WCIS Cable and Software

In order to perform any of the troubleshooting steps described in this section or to change the application/configuration of the VAV actuator, a WCIS cable (or RJ-11 to serial cable, P/N: 250804701) and WCIS software is required.

Connect a laptop loaded with the WCIS software to the controller using the cable. The software is available as a free download on Daikin Applied's sales portal: http://salesportal.daikinapplied.com/Biz/Software/Secure/MST_VAV/MSTVAVSWList. If you do not have access to this site, or need assistance using the WCIS software, contact the Daikin Applied Controls Customer Support group at 866-462-7829.

Preventive Maintenance

Most controller components are designed so that, under normal circumstances, they do not require preventive maintenance. Periodic inspections, voltage checks, and point checks are normally not required. The rugged design makes most preventive maintenance unnecessary. However, devices that are exposed to dusty or dirty environments may require periodic cleaning to function properly.

Safety Features

The controller board stores the controller's address, applications, and point values. In the event of a power failure or a reset, these values are retrieved from the controller's permanent memory and are used by the controller unless overridden by a field panel. If one of the following conditions occurs, the controller will activate safety features present in its fail-safe mode.

- Sensor failure – (See [Applications and Features](#) under “[Controller Self-Regulation and Maintenance](#)”)
- Loss of power – Upon controller power loss, communication with the controller is also lost. The controller will appear as failed (*F*) or in alarm due to communication loss at the field panel.

Controller LEDs

To determine if the controller is powered up and running properly, verify the Basic Sanity Test (BST) LED is flashing ON and OFF once per second. The controller contains seven LEDs located on the circuit board. See [Table 2 on page 6](#) for more information about the controller's LEDs.

NOTE: The TX and RX LEDs indicate communication over the BACnet network.

Automated Fault Detection and Diagnostics (Checkout)

The controller has a built-in checkout procedure that performs a basic fault detection and diagnostic routine. It can be manually initiated at any time after the controller has been installed. This procedure tests all of the necessary I/O and ensures the controller can operate within the set airflow range, between CLG FLOW MIN and CLG FLOW MAX.

To perform the checkout procedure, set CHK OUT to YES. When the procedure has completed, CHK OUT returns to NO and the results display in CHK STATUS. See [Table 4](#) for the description associated with each value of CHK STATUS.

Table 4: CHK STATUS Values and Associated Descriptions

CHK STATUS Values	Description
-1	Checkout procedure has not been run since last controller initialization.
0	No errors found.
1	Room temperature sensor (RTS) failed.
2	Room setpoint dial failed [If STPT DIAL is set to YES].
4	Air velocity sensor (AVS) failed.
8	Controller could not reach CLG FLOW MIN or below.
16	Controller could not reach CLG FLOW MAX or above.
32	Controller did not read low (zero) flow when damper closed.

NOTE: Multiple failures are added together and displayed as one value. For example, if the room temperature sensor failed (1) and the controller could not reach CLG FLOW MAX, CHK STATUS displays 17.

CHK STATUS Code Descriptions and Troubleshooting Steps

1. Room temperature sensor failed – CHK STATUS = 1

- a. The cable for the room temperature sensor may be unplugged or loose. Check both ends to ensure the cable is securely seated.
- b. Connect directly to the controller through the room temperature sensor connection on the controller and check whether communication is possible.
 - i. If communication is successful the problem lies in the room temperature sensor or its cable.
 - ii. If communication is not possible, the problem is with the controller itself.

2. Room setpoint dial failed – CHK STATUS = 2

- a. The cable for the room temperature sensor may be unplugged or loose. Check both ends to ensure the cable is securely seated.
- b. The controller may be incorrectly set to use a setpoint dial with a sensor that does not have the dial. If the sensor has no dial, change STPT DIAL from YES to NO.
- c. Connect directly to the controller through the room temperature sensor connection on the controller and check whether communication is possible.
 - i. If communication is successful the problem lies in the room temperature sensor or its cable.
 - ii. If communication is not possible, the problem is with the controller itself.

3. Air velocity sensor failed – CHK STATUS = 4

- a. The sensor tubing may be blocked, leaking, or disconnected. Check for pinched, disconnected, or cracked sensor tubing. Correct as needed.
- b. The tubing connections for the air velocity sensor may be reversed. Re=pipe if HI and LO connections are incorrect.
- c. The sensor or the controller may be faulty.

4. Controller could not reach CLG FLOW MIN or below – CHK STATUS = 8

- a. The actuator on the controller may be loose on the damper shaft. Follow these torque guidelines:
 - i. -70 ± 5 inch pounds – Solid Metal shaft
 - ii. -37 ± 2 inch pounds – plastic, graphite, composite, or hollow metal shafts (Hollow metal shafts require an insert to prevent shaft damage)
- b. The tubing for the air velocity sensor may be pinched, disconnected, or cracked. Check the tubing and correct as needed.
- c. The tubing connections for the air velocity sensor may be reversed. Re-pipe if HI and LO connections are incorrect.
- d. The Box Sizing information may be incorrect. Check the values of the following BACnet points and correct as needed:
 - i. DUCT AREA
 - ii. FLOW COEFF
 - iii. CLG FLOW MIN
 - iv. CLG FLOW MAX
- e. The Motor Setup information may be incorrect. Check the values of the following points and correct as needed:
 - i. MTR SETUP
 - ii. MTR1 TIMING
 - iii. DMPR ROT ANG
- f. The air velocity sensor may need calibration. Set CAL AIR to YES to run the calibration sequence. When CAL AIR returns to NO, indicating that the sequence is finished, run the checkout procedure again to see whether the problem has been corrected.

- g. The box may not have been balanced correctly. Contact your local Daikin representative.

5. The controller could not reach CLG FLOW MAX or above – CHK STATUS = 16

- a. Check for the problems described for CLG FLOW MIN (CHK STATUS = 8)
- b. The box may be starved for air. Check the unit state of the central air handler to see if it is OFF. If it is ON, check the duct static pressure. If it is within a desirable range, the issue is with the VAV box and not the air handler.

6. The controller did not read low (zero) flow when damper closed – CHK STATUS = 32

- a. Check for the problems described for CLG FLOW MIN (CHK STATUS = 8)
- b. The damper shaft may not be secured correctly to the actuator on the controller so that when the actuator is fully closed, the damper does not completely shut off airflow.
- c. Airflow calibration (at zero) may need to be performed ensuring the damper is fully closed and/or the air handling unit is OFF.

Additional Comments

The controller, as shipped from the factory, keeps all associated equipment OFF. The controller and its equipment are released to application control at start-up.

If the temperature swings in the room are excessive or if there is trouble in maintaining the setpoint, contact your Daikin representative.

Overview

The glossary contains terms and acronyms that are used in this manual. For definitions of point database descriptors, see section 3 “Point Database,” in this manual.

AI

Analog Input. A point receiving a signal that represents a condition that has more than two states. For example, flow rate sensors (water or air), temperature sensors (room or duct), pressure sensors (static or velocity), and humidity sensors (room, duct, or outdoor).

airflow

Rate at which a volume of air moves through a duct. Usually expressed in cubic feet per minute (cfm) or liters per second (lps).

AVS

Air Velocity Sensor.

AZM

Autozero Module. Equipment controller device used to calibrate the Variable Air Volume Controller’s internal air velocity transducer without changing the volume of air being delivered to a space.

centralized control

Type of control offered by a controller that is connected by means of the BACnet network.

cfm

Cubic Feet per Minute.

control loop

PID algorithm that is used to control an output that is based on a setpoint and an input reading from a sensor.

DDC

Direct Digital Control.

DI

Digital Input. Physical input point that receives a two-state signal (ON/OFF, OPEN/CLOSED, YES/NO).

DO

Digital Output. Physical output point that sends a two-state signal (ON/OFF, OPEN/CLOSED, YES/NO). equipment controller

equipment controller

Device that provides additional point capacity to a field panel or provides individual room or mechanical equipment control.

field panel

A device containing a microprocessor for centralized control of system components and equipment controllers.

BACnet network

Standard open protocol network consisting of equipment controllers, end devices, fume hoods, etc.

LPS

Liters per Second.

loopout

Output of the control loop expressed as a percentage.

override switch

Button on a room temperature sensor that an occupant can press to change the status of a room from unoccupied to occupied (or from night to day) for a predetermined time.

pressure independent

Variable Air Volume (VAV) room temperature control system in which the temperature drives an airflow setpoint.

PID

Proportional, Integral, Derivative. Generally refers to a type of control scheme.

RTS

Room Temperature Sensor.

setpoint

Virtual point that stores a point value such as a temperature setting. Points that monitor inputs, such as temperature, report actual values.

slave mode

Default application that displays when power is first applied to an equipment controller. No control action is initiated in the slave mode.

stand-alone control

Type of control offered by a controller that is providing independent DDC control to a space.

Terminal Equipment Controller

Daikin product family of equipment controllers (one is the VAV Controller - Electronic Output) that house the applications software used to control terminal units, such as heat pumps, VAV terminal boxes, fan coil units, unit ventilators, etc.

unbundle

Term used to describe the entering of a point that resides in a controller's database into the field panel's database so that it can be monitored and controlled from the field panel.

VAV

Variable air volume. Ventilation system that changes the amount of air supplied to and exhausted from the rooms served.



Daikin Applied Training and Development

Now that you have made an investment in modern, efficient Daikin equipment, its care should be a high priority. For training information on all Daikin HVAC products, please visit us at www.DaikinApplied.com and click on Training, or call 540-248-9646 and ask for the Training Department.

Warranty

All Daikin equipment is sold pursuant to its standard terms and conditions of sale, including Limited Product Warranty. Consult your local Daikin Applied representative for warranty details. To find your local Daikin Applied representative, go to www.DaikinApplied.com.

Aftermarket Services

To find your local parts office, visit www.DaikinApplied.com or call 800-37PARTS (800-377-2787). To find your local service office, visit www.DaikinApplied.com or call 800-432-1342.

This document contains the most current product information as of this printing. For the most up-to-date product information, please go to www.DaikinApplied.com.

Products manufactured in an ISO Certified Facility.