

Panasonic®

Operating Instructions

HDD Recorder
Model No. **DMR-HWT250**
DMR-HWT150

DIGA
High Definition

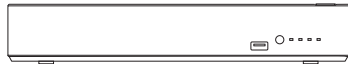

Thank you for purchasing this product.

Please read these instructions carefully before using this product, and save this manual for future use.

Software (Firmware) Update



To support the latest features, it's very important you install the latest updates to maintain proper operation of your unit.

For details, refer to "Software (Firmware) Update" (⇒ 66) or
<http://panasonic.jp/support/global/cs/> (This site is in English only.)

Model number suffix "EB" denotes UK model.

Safety precautions

WARNING

Unit

- To reduce the risk of fire, electric shock or product damage,
 - Do not expose this unit to rain, moisture, dripping or splashing.
 - Do not place objects filled with liquids, such as vases, on this unit.
 - Use only the recommended accessories.
 - Do not remove covers.
 - Do not repair this unit by yourself. Refer servicing to qualified service personnel.
 - Do not let metal objects fall inside this unit.
 - Do not place heavy items on this unit.

AC mains lead

- To reduce the risk of fire, electric shock or product damage,
 - Ensure that the power supply voltage corresponds to the voltage printed on this unit.
 - Insert the mains plug fully into the socket outlet.
 - Do not pull, bend, or place heavy items on the lead.
 - Do not handle the plug with wet hands.
 - Hold onto the mains plug body when disconnecting the plug.
 - Do not use a damaged mains plug or socket outlet.
- The mains plug is the disconnecting device. Install this unit so that the mains plug can be unplugged from the socket outlet immediately.

CAUTION

Unit

- Do not place sources of naked flames, such as lighted candles, on this unit.
- This unit may receive radio interference caused by mobile telephones during use. If such interference occurs, please increase separation between this unit and the mobile telephone.
- This unit is intended for use in moderate climates.

Placement

- Place this unit on an even surface.
- To reduce the risk of fire, electric shock or product damage,
 - Do not install or place this unit in a bookcase, built-in cabinet or in another confined space. Ensure this unit is well ventilated.
 - Do not obstruct this unit's ventilation openings with newspapers, tablecloths, curtains, and similar items.
 - Do not expose this unit to direct sunlight, high temperatures, high humidity, and excessive vibration.

Batteries

- Danger of explosion if battery is incorrectly replaced. Replace only with the type recommended by the manufacturer.
- Mishandling of batteries can cause electrolyte leakage and may cause a fire.
 - Do not mix old and new batteries or different types at the same time.
 - Do not heat or expose to flame.
 - Do not leave the battery(ies) in a car exposed to direct sunlight for a long period of time with doors and windows closed.
 - Do not take apart or short circuit.
 - Do not recharge alkaline or manganese batteries.
 - Do not use batteries if the covering has been peeled off.
 - Remove batteries if you do not intend to use the remote control for a long period of time. Store in a cool, dark place.
- When disposing of the batteries, please contact your local authorities or dealer and ask for the correct method of disposal.



Caution for AC Mains Lead

(For the AC mains plug of three pins)

For your safety, please read the following text carefully.

This appliance is supplied with a moulded three pin mains plug for your safety and convenience. A 5-ampere fuse is fitted in this plug.

Should the fuse need to be replaced please ensure that the replacement fuse has a rating of 5-ampere and that it is approved by ASTA or BSI to BS1362.

Check for the ASTA mark  or the BSI mark  on the body of the fuse.

If the plug contains a removable fuse cover you must ensure that it is refitted when the fuse is replaced.

If you lose the fuse cover the plug must not be used until a replacement cover is obtained. A replacement fuse cover can be purchased from your local dealer.

Before use

Remove the connector cover.

How to replace the fuse

The location of the fuse differ according to the type of AC mains plug (figures A and B). Confirm the AC mains plug fitted and follow the instructions below.

Illustrations may differ from actual AC mains plug.

1. Open the fuse cover with a screwdriver.

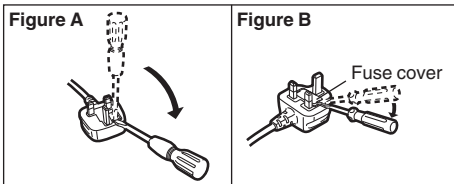

2. Replace the fuse and close or attach the fuse cover.

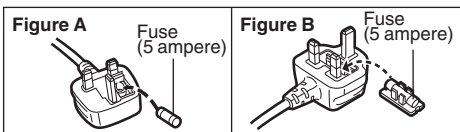

Supplied accessories

Please check and identify the supplied accessories.

(Product numbers are correct as of August 2015. These may be subject to change.)

- Remote control (N2QAYB001058):** 1 pc.
 - Batteries for remote control:** 2 pcs.
 - AC mains lead (K2CT2YY00098):** 1 pc.
 - RF coaxial cable (K2KYYYY00247):** 1 pc.
 - HDMI cable (K1HY19YY0011):** 1 pc.
- Do not use AC mains lead with other equipment.

Insert batteries

Insert so the poles (+ and -) match those in the remote control.

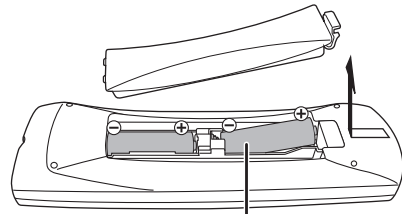

R6/LR6, AA

(Alkaline or manganese batteries)

About descriptions in these operating instructions

- These operating instructions are applicable to models DMR-HWT250 and DMR-HWT150. The illustrations in these Operating Instructions show images of DMR-HWT250 unless otherwise indicated.
- **HWT250** : indicates features applicable to DMR-HWT250 only.
- **HWT150** : indicates features applicable to DMR-HWT150 only.
- Pages to be referred to are indicated as "⇒ ○○".
- Images are for illustration purpose, contents may change without notice.

Table of contents

Safety precautions	2
Caution for AC Mains Lead.	3
Supplied accessories	3

Getting started

HDD and media information	6
Unit care	9
Control reference guide.	10
Connection.	12
Settings.	14
FUNCTION MENU screen	18

Watching broadcasts

Watching broadcasts	19
Freeview Play	22

Recording

Recording TV programmes.	24
Timer recording.	26

Playing back video

Playing titles on the HDD	31
Playing titles on the media	33
Operation during play.	34

Editing video

Deleting/Editing titles	37
-----------------------------------	----

Copying video

Copying titles	40
--------------------------	----

Photo and Music

Playing photos.	41
Editing photos	43
Copying photos.	44
Playing music	45
Copying/Deleting music.	46

Network

Smart Home Networking (DLNA).	47
TV Anywhere.	51
Enjoying Network Service	51

With Other Equipment

Copying the HD Video (AVCHD).	52
Registering the external HDD (USB HDD)	53

Convenient functions

VIERA Link functions.	54
Playback menu	55
Basic Settings	57
4K Networking.	66
Software (Firmware) Update	66
Other operations.	67

Troubleshooting

Troubleshooting guide	68
---------------------------------	----

Reference

Specifications	73
Licenses.	76
Index	78

Getting started

Watching broadcasts

Recording

Playing back video

Editing video

Copying video

Photo and Music

Network

With Other Equipment

Convenient functions

Troubleshooting



Reference

HDD and media information

For more details, refer also to the specifications. (⇒ 73)

Recordable/playable contents

(-: Impossible)

Media type	Standard symbol	Playable contents	Recordable contents
Built-in hard disk drive (HDD)	 HDD	<ul style="list-style-type: none"> • Video • AVCHD/AVCHD 3D • MKV • MP4 • MPEG2 • Xvid 	<ul style="list-style-type: none"> • JPEG • MPO (3D photo) • AAC • FLAC • MP3 • WAV • WMA
External hard disk drive (USB HDD) (⇒ 8)	 USB HDD	<ul style="list-style-type: none"> • Video^{※1} • AVCHD/AVCHD 3D^{※2,3} • MKV • MP4 • MPEG2 • Xvid • JPEG • MPO (3D photo) 	<ul style="list-style-type: none"> • AAC • FLAC • MP3 • WAV • WMA <p style="text-align: center;">-</p>
USB memory	 USB	<ul style="list-style-type: none"> • AVCHD/AVCHD 3D^{※2,3} • MKV • MP4 • MPEG2 • Xvid • JPEG • MPO (3D photo) 	<p style="text-align: center;">-</p>

※1 It cannot be recorded directly. (Only compatible with copying from the built-in HDD)

※2 Recorded with AVCHD format compatible devices (Panasonic video camera, etc.). It may not be able to play back, add, or edit depending on the device.

※3 It cannot be played back directly from the USB HDD or USB memory. Playback is possible by copying to the built-in HDD. (⇒ 52)



- With certain recording states and folder structures, the play order may differ or playback may not be possible.
- It may not be possible to play the above media in some cases due to the type of media, the condition of the recording, the recording method, and how the files were created.

The recording and playback of content on this or any other device may require permission from the owner of the copyright or other such rights in that content. Panasonic has no authority to and does not grant you that permission and explicitly disclaims any right, ability or intention to obtain such permission on your behalf. It is your responsibility to ensure that your use of this or any other device complies with applicable copyright legislation in your country. Please refer to that legislation for more information on the relevant laws and regulations involved or contact the owner of the rights in the content you wish to record or playback.

Indemnity concerning recorded content

Panasonic does not accept any responsibility for damages directly or indirectly due to any type of problems that result in loss of recording or edited content (data), and does not guarantee any content if recording or editing does not work properly. Likewise, the above also applies in a case where any type of repair is made to the unit (including any other non-HDD related component).

Information about contents

■ Broadcast Recordings

Numbers of titles that can be recorded:

Media	Maximum titles
HDD	3000

- Maximum numbers of titles are including recordings of HD CAMCORDER.

■ HD CAMCORDER Recordings

MPEG-4 AVC/H.264 (based on AVCHD)

Numbers of titles that can be recorded:

Media	Maximum titles
HDD	3000

- Maximum numbers of titles are including recordings of Broadcast.

■ Photo files

Compatible pixels:

Between 34×34 and 8192×8192 pixels

Sub sampling: 4:2:2, 4:2:0

(Motion JPEG is not supported.)

Maximum numbers of contents:

Media	Folders	Files
HDD	–	20000
USB device	500	10000

■ Video files/Audio files

Numbers of contents that can be copied to internal HDD:

Contents	Maximum numbers of folders and files
Video	20000
Audio	20000

USB device:

- Each folder can store up to 1000 files.
- We recommend that you limit the depth of folder trees to about five levels.
- Bit rate up to 100 Mbps/resolution up to 3840×2160 25p/30p, 4096×2160 24p. (MP4 only)

About extension of files

MKV:	“.mkv”			
Subtitle text files:	“.srt”	“.sub”	“.txt”	
MP4:	“.mp4”	“.mov”		
MPEG2:	“.mpg”	“.mpeg”	“.m2ts”	“.mts” “.ts”
Xvid:	“.avi”			
Subtitle text files:	“.srt”	“.sub”	“.txt”	
JPEG:	“.jpg”			
MPO:	“.mpo”			
AAC:	“.m4a”			
FLAC:	“.flac”			
MP3:	“.mp3”			
WAV:	“.wav”			
WMA:	“.wma”			



- The video file and subtitle text files are inside the same folder, and the file names are the same except for the file extensions.
- Some files may not be played back even if they have these extensions.

HDD and media information

Recording mode

Recording Mode	DR	HG/HX/HE/HL/HM	XP/SP/LP/EP
Feature	Programmes can be recorded in a nearly perfect broadcasted state.	Recording can be done with reduced recording volume in High definition (HD) quality* ¹ .	Recording can be done with reduced recording volume in Standard definition (SD) quality.
Multiple audio	Record all multiple audio	Record only one audio* ²	
Audio Description	Can be recorded	Can be recorded* ²	
Subtitles	Can be recorded	Can be recorded (only one subtitle)* ³	
Surround audio	Surround audio as the broadcast	Stereo audio	

*¹ The SD quality programme cannot be converted to HD quality.

*² You cannot select during play whether it activates or deactivates.

*³ You cannot select during play whether it appears or disappears.

Approximate recording times

Refer to "Recording modes and approximate recording times". (⇒ 73)

Notes

Notes for the USB device

You can use an external HDD (USB HDD) in the following two ways (A single HDD cannot handle those two ways simultaneously), and a USB memory for data files.

• **For recorded titles**

Moving titles in the built-in HDD to a USB HDD to save the capacity of the built-in HDD.

- The USB HDD must first be registered on this unit. (⇒ 53)
- The USB HDD over 3 TB is not usable.

• **For data files**

Playing back MP4, JPEG, MP3, etc. in a USB device with this unit.

- The USB device must be formatted in FAT12, FAT16, FAT32 or NTFS file system.
- The USB device over 2 TB is not usable.



- This unit supports USB 2.0 High Speed.
- Although this unit can use USB 3.0 devices as USB 2.0 devices.
- This unit does not recognise USB HDDs other than those in which the size of one sector is 512-bytes or 4096-bytes. (For details, consult the dealer of your USB HDD.)
- This unit supports USB mass storage device class.
- This unit does not guarantee connection with all USB devices.

Unit care

HDD/USB HDD handling care

- The HDD is a high precision recording instrument and is easily susceptible to damage. Therefore, be careful of the following points while the unit is turned on, especially during operation, otherwise the HDD and the recorded content may be damaged:
 - Do not subject the unit to any vibration and shock.
 - Do not remove the AC mains lead from the household mains socket.
- **The HDD is a temporary storage device**
This unit cannot save (backup) the HDD titles to media. You have to be very careful when handling the unit and editing the title.
- **If the HDD or USB HDD is damaged, the recorded content cannot be recovered.**

Setup precautions

- **Do not place on anything that generates heat like a Set Top Box, etc.**
- **Place in an area where condensation does not occur. Conditions where condensation may occur**
 - When there is an extreme change in temperature.

In the above situation, **without turning the unit on**, let the unit adjust to the room temperature and wait 2–3 hours until condensation is gone.

- **The unit may breakdown if cigarette smoke or bug spray/vapour, etc. gets inside the unit.**

When moving the unit

- 1 Switch the unit to standby mode. ((⏻/|) will flash. Wait until it goes off.)
- 2 Remove the AC mains lead from the household mains socket.
- 3 Move only after the unit has come to a complete stop (approx. 3 minutes) in order to avoid subjecting to vibration and shock. (Even after the unit is switched to standby mode, the HDD continues operating for a short time.)

Cleaning

- Wipe with a soft, dry cloth.
- Never use alcohol, paint thinner or benzine to clean this unit.
- Before using chemically treated cloth, carefully read the instructions that came with the cloth.

When requesting this unit for repair

The registration of the USB HDD may be cancelled in the process of repairing this unit. You can use the USB HDD again by re-registering, but all recorded content already on the USB HDD will be lost. In such cases, the recorded content (data) cannot be recovered.

To dispose or transfer this unit

This unit may contain private information. Before disposing of or transferring this unit, perform the following to delete the data, including personal or secret information:

- Format HDD (⇒ 59)
- Perform "Shipping Condition" (⇒ 65)

Control reference guide

Instructions for operations are generally described using the remote control.

Remote control

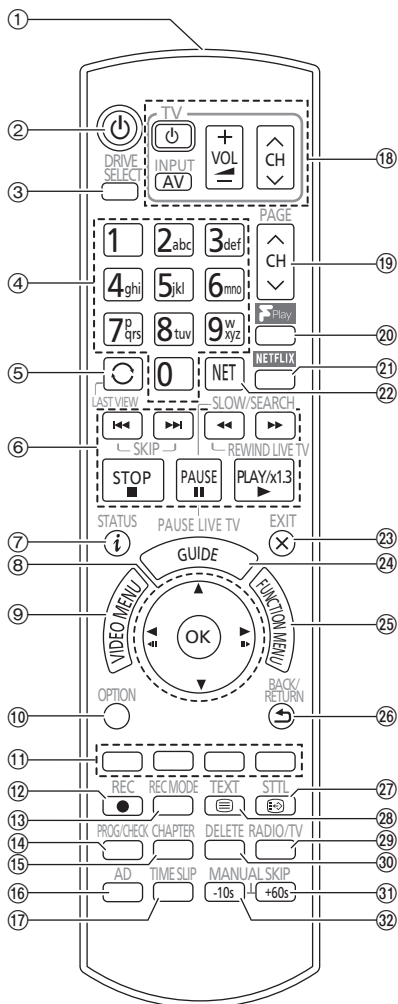

- ① Transmit the remote control signal
 - Point it at remote control signal sensor on this unit. (⇒ 11)
- ② Switch the unit from on to standby mode or vice versa
- ③ Select drive (HDD or USB)
- ④ Select channels and title numbers, etc./Enter numbers or characters
- ⑤ Switch to the previously watched channel (⇒ 19)
- ⑥ Basic operations for recording and play, REWIND LIVE TV/PAUSE LIVE TV (⇒ 21)
- ⑦ Show Information (⇒ 19, 32, 34)
- ⑧ Selection/OK, Frame-by-frame (⇒ 34)
- ⑨ Show Video Menu (⇒ 31)
- ⑩ Show OPTION menu (⇒ 37, 43, 55)
- ⑪ Colour buttons (red, green, yellow, blue) (Use in accordance with instruction on the screen.)
- ⑫ Start recording (⇒ 24)
- ⑬ Select a recording mode/conversion mode (⇒ 24)
- ⑭ Show the Timer Recording screen (⇒ 28)
- ⑮ Create chapter (⇒ 35)
- ⑯ Listen to Audio Description (⇒ 20, 35)
- ⑰ Skip the specified time (⇒ 35)
- ⑱ TV operation buttons (⇒ 14)
- ⑲ Channel select (⇒ 19)/Change pages in the Video Menu screen etc.
- ⑳ Show the Freeview Play Catch Up Service screen (⇒ 23)
- ㉑ Show NETFLIX screen (⇒ 51)
- ㉒ Show the Network Service screen (⇒ 51)
- ㉓ Exit the menu screen
- ㉔ Show the TV Guide screen (⇒ 22)
- ㉕ Show the FUNCTION MENU screen (⇒ 18)
- ㉖ Return to previous screen
- ㉗ Show subtitles (⇒ 19, 35)
- ㉘ Show Digital Teletext (⇒ 20)
- ㉙ Switching to the radio channel list (⇒ 19)
- ㉚ To delete unwanted recorded titles, timer programmes, video, photo or music (⇒ 37)
- ㉛ Skip approx. 1 minute forward (⇒ 34)
- ㉜ Skip approx. 10 seconds backward (⇒ 34)

Main unit

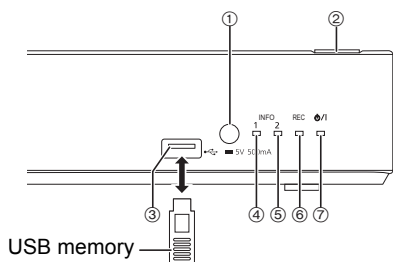

- While writing to/reading from the media, do not switch the unit to standby mode or remove the media. Such action may result in loss of the media contents.
- When inserting the media, ensure that it is facing the right way up.

- ① Remote control signal sensor
 - Angle: Approx. 20° up and down, 30° left and right
 - Distance: Within approx. 7 m in front of the unit
- ② **Standby/on switch (⏻/⏻)**

Press to switch the unit from on to standby mode or vice versa. In standby mode, the unit is still consuming a small amount of power.
- ③ USB port
- ④ Information LED1
 - Flashes when a USB memory is inserted.
 - Displays the various states of this unit. (⇒ 72)
- ⑤ Information LED2
 - Flashes for approx. 20 seconds when DLNA compatible equipment is connected to this unit over the network (when this unit is used as a server). (⇒ 47)
 - Lights up during firmware update. (⇒ 66)
 - Displays the various states of this unit. (⇒ 72)
- ⑥ Recording LED
 - Lights up while recording.
 - Flashes while recording is paused and before recording starts.
- ⑦ POWER LED/Remote control signal indicator
 - Flashes when the power is turned on/off. Wait for the LED to turn solid green before using this unit.
 - Flashes when this unit receives remote control signals.

Connection

3D programmes or 4K images can be played back when this unit is connected to 3D or 4K compatible terminal of a 3D or 4K compatible TV.

- Before connection, turn off all equipment and read the appropriate operating instructions.
- If you use an optional HDMI cable, use the High Speed HDMI cables. Non-HDMI-compliant cables cannot be utilized.

It is recommended that you use Panasonic's HDMI cable.

When outputting 1080p or 24p (4K) signal, please use HDMI cables 5.0 meters or less.

The HDMI-compliant cable is supplied with this unit.

- When the unit is not to be used for a long time

To save power, unplug it from the household mains socket. This unit consumes a small amount of power, even when the unit is in standby mode. (⇒ 73)

Basic connections

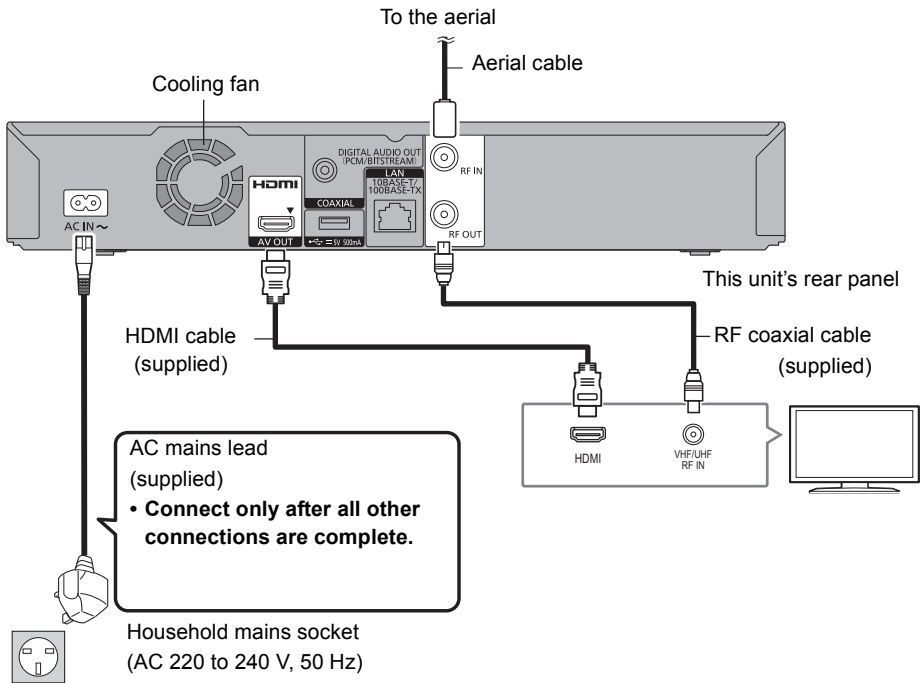

- Keep the RF coaxial cables as far away as possible from other cables.

Amplifier/receiver connections

HDMI terminal

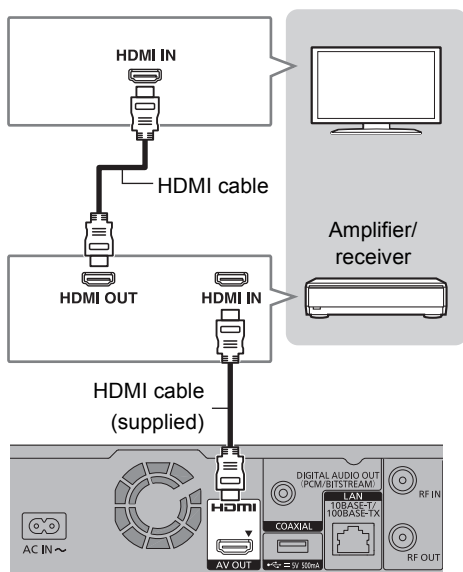

- You will not be able to view 3D programmes or 4K images with this connection if your amplifier/receiver is not 3D or 4K compatible.

HWT250

DIGITAL AUDIO OUT terminal

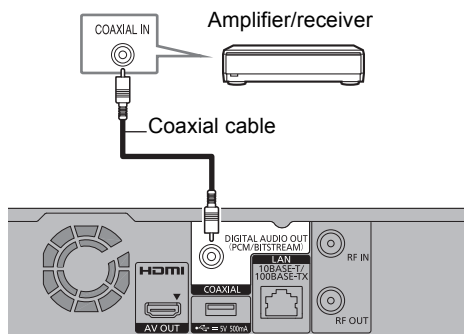

- When you do not want the audio to be output from the TV, set "HDMI Audio Output" to "Off" (⇒ 61).

Network connection

When this unit is connected to the network, you can enjoy network functions (DLNA function, Network Service, TV Anywhere, etc.).

For details about connection method, refer to the instructions supplied with the connected equipment.

After you make the LAN cable/Wireless LAN connection, the network setting is needed. (⇒ 16, Easy Network Setting)

LAN cable connection

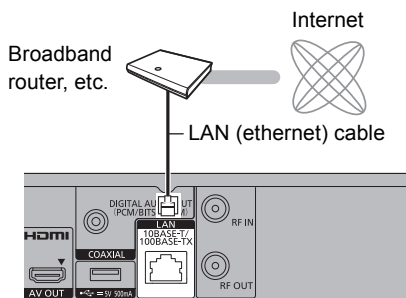

- Use category 5 or above straight LAN cables (STP) when connecting to peripheral devices.

Wireless LAN connection

About wireless LAN connection (⇒ 16, Easy Network Setting)



- For up-to-date compatibility information on your Wireless router, refer to <http://panasonic.jp/support/global/cs/> (This site is in English only.)
- The unit is not compatible with public wireless LAN services.

Settings

TV operation buttons

The TV can be operated from the TV operation buttons of the remote control.

- Perform the setting if you cannot operate the TV with the TV operation buttons.

While pressing [TV ⏻], enter the code with the number buttons.

Manufacturer and Code No.

Manufacturer	Code	Manufacturer	Code
Panasonic	01/02/03/04	NEC	36
AIWA	35	NOBLEX	33
AKAI	27/30	NOKIA	25/26/27/60/61
BEKO	05/71/72/73/74	NORDMENDE	10
BENQ	58/59	OLEVIA	45
BRANDT	10/15	ONWA	30/39/70
BUSH	05	ORION	05
CENTREX	66	PEONY	49/69
CURTIS	05	PHILCO	41/48/64
DAEWOO	64/65	PHILIPS	05/06/46
DESMET	05	PHONOLA	05
DUAL	05	PIONEER	37/38
ELEMIS	05	PROVIEW	52
FERGUSON	10/34	PYE	05
FINLUX	61	RADIOLA	05
FISHER	21	SABA	10
FUJITSU	53	SALORA	26
FUNAI	63/67	SAMSUNG	32/42/43/65/68
GOLDSTAR	05/50/51	SANSUI	05
GOODMANS	05	SANYO	21/54/55/56
GRADIENTE	36	SCHNEIDER	05/29/30
GRUNDIG	09	SEG	05/69/75/76/77/78
HITACHI	05/22/23/40/41	SELECO	05/25
IRRADIO	30	SHARP	18
ITT	25	SIEMENS	09
JVC	17/30/39/70	SINUDYNE	05
KDS	52	SONY	08
KOLIN	45	TCL	31/33/66/67/69
KONKA	62	TELEFUNKEN	10/11/12/13/14
LG	05/50/51	TEVION	52
MAG	52	THOMSON	10/15/44
METZ	05/28/79	TOSHIBA	16/57
MITSUBISHI	05/19/20/47	WHITE WESTINGHOUSE	05
MIVAR	24	YAMAHA	18/41



- If your TV brand has more than one code listed, select the one that allows correct operation.
- If the brand of your TV is not listed or the code number is invalid for your TV, this remote control is not compatible with your TV.

Easy Setting

- 1 Turn on the TV, then select the appropriate AV input to suit the connections to this unit.
 - 2 Press [⏻] on the remote control or [⏻/I] on this unit.
 - The Easy Setting will start at the initial power on.
- Auto Setup starts.
(This operation may take some time.)
e.g.,

- 3 Clock will be set automatically.
If the clock setting screen appears, set the time manually (⇒ 65, Clock).
 - If the region selection screen appears, select repeatedly until you reach the available region.
- 4 Enter the PIN.
This PIN will be used only for the Owner ID-Data Entry screen.

- 1 Press the number buttons to enter 4-digit PIN.
- 2 Repeat step 1 to confirm.
 - Make a note of PIN in case you forget it. The PIN number cannot be reset.
 - Steps 4 – 6 will be skipped in the Easy Setting after “Shipping Condition” (⇒ 65) is performed. (⇒ go to step 7 on page 15)

- 5** Set the Owner ID-Data Entry (“NAME”, “HOUSE NO” and “POSTCODE”).

e.g.,

Owner ID-Data Entry	
PIN	0000
NAME	
HOUSE NO	
POSTCODE	

Change PIN Select RETURN

- 1 Select the item, then press [OK].
- 2 Select the character, then press [OK]. Repeat this step.
- 3 Press [BACK/RETURN].
- 4 Repeat steps 1-3 to enter all data.
- 5 Press [BACK/RETURN] to exit from the Owner ID-Data Entry screen.

- 6** Enter the new PIN for parental control.

PIN Entry	
Enter a new 4-digit PIN, then press OK. This PIN will be used for controlling viewing and playback. PIN will be set to “0000” by pressing “RETURN” when there is no number input.	
RETURN	Number [0] - [9]

- The default PIN is “0000”.
- 1 Enter the new 4-digit PIN with the number buttons.
 - **Make a note of the PIN you have decided on in case you forget it.**
 - 2 Press [OK].
- 7** Set “Quick Start” to “On”, “Off” or “Timer Setting for Quick Start”, then press [OK]. For details, refer to “Quick Start”. (⇒ 64)

When “Easy Setting has been completed.” appears, Easy Setting is complete.

- Select “Yes” to set network settings.
- Select “No” to finish the Easy Setting.

To stop partway

Press [BACK/RETURN].

To restart setup (⇒ 57, Auto Setup)

To display the Owner ID information on TV

- 1 While the unit is on, press and hold [OK], the yellow button and the blue button on the remote control at the same time for more than 5 seconds.
 - The “INFO1” indicator on the unit will flash.
- 2 Press [▶] repeatedly until the “REC” indicator on this unit lights up.
- 3 Press [OK] on the remote control. The PIN is not displayed.

To change PIN for parental control

Refer to “PIN Entry”. (⇒ 65)

To change the region for Channel Sorting

Refer to “Channel Sorting by Region”. (⇒ 58)



- If tuning is cancelled partway through, it may not be possible to receive the channels. Restart setup again.

Settings

Easy Network Setting

After completing “Easy Setting”, you can continue with “Easy Network Setting”.

Select “Wired” or “Wireless”, then press [OK].

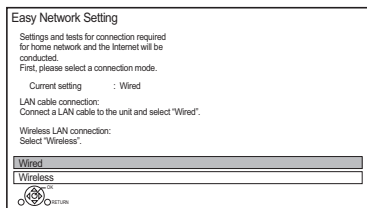

“Wired” connection

Follow the on-screen instructions to apply your connection settings.

“Wireless” connection

Before beginning wireless connection setup

- Obtain your network name (SSID^{*1}).
- If your wireless connection is encrypted, please be sure that you know your encryption key.

Select “Search for wireless network” or “WPS (PUSH button)” and press [OK], then follow the on-screen instructions and apply the settings.

Search for wireless network:

The available wireless networks will be displayed. Select your network name and press [OK].

- If your Network name is not displayed, search again by pressing the red button on the remote control.
- Stealth SSID will not be displayed. Enter manually by using “Wireless Settings”. (⇒ 62)
- If your wireless network is encrypted, Encryption Key Input Screen will be displayed. Input the encryption key of your network.

WPS (PUSH button):

If your Wireless router supports WPS (PUSH button), you can easily perform the settings by pressing WPS button on it.

WPS (Wi-Fi Protected Setup™) is a standard that facilitates settings relating to the connection and security of wireless LAN devices.

- 1 Press WPS button or corresponding button of Wireless router until the lamp starts flashing.
 - For details, refer to the operating instructions of Wireless router.
- 2 Press [OK].

e.g.,

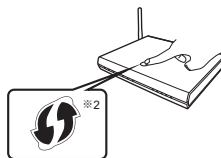

- ^{*1} SSID:
An SSID (Service Set IDentification) is a name used by wireless LAN to identify a particular network. Transmission is possible if the SSID matches for both devices.
- ^{*2} The wireless router compatible with Wi-Fi Protected Setup™ may have the mark.

To restart Easy Network Setting

- 1 Press [FUNCTION MENU]. (⇒ 18)
- 2 Select "Basic Settings" in "Setup", then press [OK].
- 3 Select "Easy Network Setting" in "Network", then press [OK].

To redo settings individually

If "Easy Network Setting" did not work properly or when you change the settings individually, perform the following steps:

- 1 Press [FUNCTION MENU]. (⇒ 18)
- 2 Select "Basic Settings" in "Setup", then press [OK].
- 3 Select "Network Settings" in "Network", then press [OK].
- 4 Refer to "Network Settings". (⇒ 62)

Check security before using Home Network function

If you set "Home Network function" to "On", all connected devices on the same network can access this unit. Ensure that the router for your home network has adequate security system to prevent unauthorised access.



- Refer to the operating instructions of the hub or router.
- If you set "Home Network function" or "TV Anywhere" to "On", the setting for "Quick Start" is fixed to "On".
- Do not use this unit to connect to any wireless network for which you do not have usage rights. During automatic searches in a wireless network environment, wireless networks (SSID) for which you do not have usage rights may be displayed; however, using these networks may be regarded as illegal access.
- After performing network settings on this unit, the settings (encryption level, etc.) of the Wireless router might change. When you have trouble getting online on your PC, perform the network settings on your PC in accordance with the settings of Wireless router.
- Please be aware that connecting to a network without encryption may result in the content of the communication being illegitimately viewed by a third party, or the leaking of data such as personal or secret information.

FUNCTION MENU screen

You can easily access the desired functions, such as playback, timer recording, the unit's settings etc. via the FUNCTION MENU.

1 Press [FUNCTION MENU].

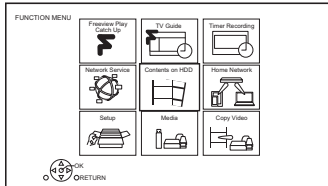

2 Select the item, then press [OK].

FUNCTION MENU list

- **Freeview Play Catch Up** (⇒ 23)
- **TV Guide** (⇒ 22)
- **Timer Recording** (⇒ 28)
- **Network Service** (⇒ 51)
 - **Contents on HDD**
 - Recorded Programmes (⇒ 31)
 - Video (AVCHD) (⇒ 31)
 - Video (MP4 / Xvid / MKV) (⇒ 32)
 - Photo (⇒ 41)
 - Music (⇒ 45)
 - **Home Network**
 - Miracast (⇒ 50)
 - DLNA Client (⇒ 48)
 - Media Renderer (⇒ 49)
 - Wi-Fi Direct (⇒ 50)
 - **Setup**
 - Basic Settings (⇒ 57)
 - You can change the unit's settings of Tuning, Sound, Display, Connection, Network etc.
 - TV Anywhere (⇒ 51)
 - Wallpaper
 - Personalize a background of the FUNCTION MENU.
 - To select from among "Photo", register photo in advance. (⇒ 42)
- **Media**
 - USB device
 - USB HDD
- **Copy Video** (⇒ 40)

Watching broadcasts

Press [CH ^ v] to select the channel.

- You can also select the channel by the following operations.
 - Using number buttons
 - Using "TV Guide" (⇒ 22)
 - Using channel information (⇒ below)

To switch to the channel you have previously watched

Press [LAST VIEW ○].

- This function will work only for the channels you have watched for more than 10 seconds.

To switch to the radio channels or to the all channels

Press [RADIO/TV].

If this unit requests a PIN

If you have locked channels (⇒ 58, Child Lock List), you may be asked to enter the PIN. In that case, enter the 4-digit PIN with the number buttons by following the on-screen instructions.

- PIN can be changed via "PIN Entry". (⇒ 65)

Using channel information

While watching a programme

Press [STATUS ⊕].

Channel information appears.

e.g.,

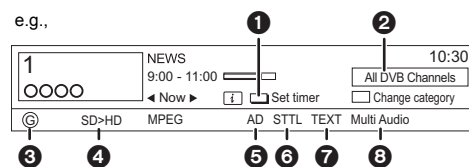

- 1 Set timer (⇒ 29)
- 2 Current Category
- 3 Guidance information for parental control (⇒ 58, Child Lock)
- 4 HD simulcast programmes
- 5 Audio Description
- 6 Subtitle
- 7 Digital teletext
- 8 Multiple audio

To show detailed information

Press [STATUS ⊕] again.

To hide the information screen

Press [EXIT ⊗].

To change Category

Press the blue button.

To register your favourite channels

- 1 Press [OPTION].
- 2 Select "Digital TV Menu", then press [OK].
- 3 Select "Favourites Edit", then press [OK].
- 4 Refer to "Favourites Edit". (⇒ 57)

To switch between the current programme and the next programme

Press [◀, ▶].

To switch to another channel

Press [▲, ▼], then press [OK].

To show subtitle

When "STTL" appears in channel information (⇒ left)

Press [STTL ⊕].

- Press again to hide subtitle.

Switching audio

When "Multi Audio" appears in channel information (⇒ left)

- 1 Press [OPTION].
- 2 Select "Multi Audio" in "Digital TV Menu", then press [OK].
- 3 Select the desired audio.
 - Press [EXIT ⊗] to exit from the screen.

Watching broadcasts

To use data service (Hybrid Broadcast Broadband TV)

To use Hybrid Broadcast Broadband TV application, perform network connection and settings. (⇒ 13, 16)

- Set “HbbTV Setting” to “On”. (⇒ 58)



- Operations may vary depending on the broadcaster.
- On-screen instructions may not correspond to the remote control buttons.
- It may take some time to show the data service.
- Some functions of the data service may be deactivated during recording.

To listen to the Audio Description

Audio Description adds an additional soundtrack to describe events on screen (narration) and aids understanding and enjoyment, particularly for visually-impaired viewers.

When “AD” appears in channel information (⇒ 19)

- 1 Press [AD].
- 2 Select “Audio Description” and set to “Automatic”.
- 3 Select “Volume”, then adjust the volume with [◀, ▶].



- Audio Description may not be available depending on the type of audio format.
- When “Dolby Digital / Dolby Digital Plus”, “MPEG” or “HE-AAC” is set to “Bitstream”, the Audio Description may not work. Set them to “PCM” (⇒ 60, Digital Audio Output).
- You can also set “Audio Description” active in the Setup menu. (⇒ 58)

To show Digital teletext (MHEG)

When “TEXT” appears in channel information (⇒ 19)

- 1 Press [TEXT ].
- 2 Use [▲, ▼, ◀, ▶], number buttons or colour buttons, etc. according to on-screen instructions.



- Some functions of Digital teletext are deactivated during recording.
- “Player PIN Control” applies access control for some MHEG services. If you have locked viewing of Digital teletext (MHEG (⇒ 58, Player PIN Control)), PIN is required to start viewing.

Aspect

You can switch the aspect ratio of the screen. (⇒ 67)

REWIND LIVE TV/PAUSE LIVE TV

This unit temporarily saves a live TV programme you are watching with this unit's tuner on HDD.

REWIND LIVE TV

You can rewind live TV programme to the point where temporary save has started (up to 1.5 hours).

PAUSE LIVE TV

You can pause live TV programme and restart watching from the paused position.

1 While watching TV

REWIND LIVE TV:

Press [SLOW/SEARCH ◀◀] to rewind.

PAUSE LIVE TV:

Press [PAUSE ||] to pause.

- The maximum amount of the temporary save is 1.5 hours.

2 When you want to resume:

Press [PLAY/× 1.3 ▶].

- You can perform search or Quick View, etc.
- If temporary save stops (⇒ right), playback will be performed by that point.

Display information

While pausing or rewinding a broadcast:

Press [STATUS ⓘ].

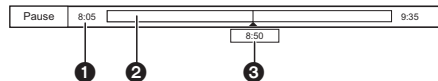

- Press [STATUS ⓘ] again.

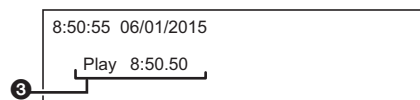

- 1 The time that you can rewind the live programme.
- 2 The amount of time temporarily saved on HDD.
- 3 The time of the current playback position.

To stop REWIND LIVE TV or PAUSE LIVE TV

- 1 Press [STOP ■].
- 2 Select "Yes", then press [OK].

To hide the display information

Press [EXIT ⊗].



- Temporary save stops in the following cases:

- When switching to other channels or other screen
- When two programmes simultaneous recording is started
- When performing PAUSE LIVE TV or REWIND LIVE TV for more than 8 hours (This may vary depending on the HDD free space.)

- These functions do not work in the following cases:

- When the clock is not set
- When two programmes simultaneous recording is started
- While copying
- While watching a programme being recorded
- When a radio programme is selected

Freeview Play

When this unit is connected to a network, it enables you to scroll back through the TV Guide for programmes from the last seven days on catch up (7 days back function), or display the list of services provided by broadcasters, such as BBC, ITV, and Channel 4 (Freeview Play Catch Up function).

Freeview Play will launch in October 2015. The following functions will be available for this unit:

- Freeview Play Side Bar (⇒ below)
- TV Guide (⇒ right)
- 7 days back function (⇒ 23)
- Freeview Play Catch Up (⇒ 23)

About the 7 days back function and Freeview Play Catch Up function

- These functions will be made available through a firmware update. (As of October 2015) For details, please check the following website. <http://panasonic.jp/support/global/cs/> (This site is in English only.)
- A network connection and related access settings are required. (⇒ 13, 16)
- Minimum broadband speed of 2 Mbps required for catch up and on demand services.

Freeview Play Side Bar

You can use the Freeview Play Side Bar to select items.

- 1 While watching a programme Press [OK].

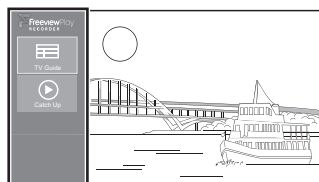

Freeview Play Side Bar

- 2 Select the item, then press [OK].
TV Guide (⇒ right)
Catch Up (Freeview Play Catch Up) (⇒ 23)

To exit

Press [BACK/RETURN].

TV Guide

- 1 While watching a programme Press [OK] to display the Freeview Play Side Bar.
- 2 Select the "TV Guide", then press [OK].
 - You can directly access the TV Guide by pressing [GUIDE].

e.g.,



Page up/down

Press and hold [CH ^ v] or [▲, ▼].

To view a programme list for another day

Press the red button, then select the item.

To set a timer recording using the TV Guide (⇒ 26)

- 3 Select the programme, then press [OK].

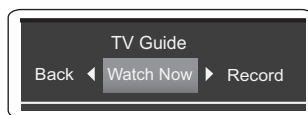

- 4 To watch the programme Select "Watch Now", then press [OK].
 - To set a timer recording, edit timer recording settings or etc., select the desired item with [◀, ▶] and press [OK].



- Selection of channel is made easy by creating a Favourite of the channels you watch often. (⇒ 57, Favourites Edit)

7 days back function

- 1** While watching a programme
Press [OK] to display the Freeview Play Side Bar.
- 2** Select the “TV Guide”, then press [OK].
 - You can directly access the TV Guide by pressing [GUIDE].
- 3** Press [◀] to display the 7 days back function screen.

e.g.,



- 4** Select the programme, then press [OK].
 - You can select a broadcaster by pressing [CH ^ v].
 - You can select a date by pressing [◀, ▶].
- 5** To watch the programme
Select “Watch Now”, then press [OK].

To return to the TV Guide screen for the current time

Press the green button.

Freeview Play Catch Up

- 1** While watching a programme
Press [OK] to display the Freeview Play Side Bar.
- 2** Select the “Catch Up”, then press [OK].
 - You can directly access Freeview Play Catch Up by pressing [F Play].

e.g.,

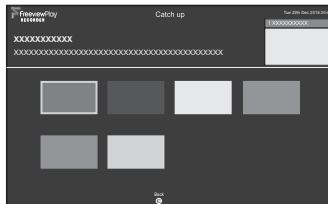

- 3** Select the item, then press [OK].
Follow the on-screen instructions and make the subsequent settings.

To exit

Press [BACK/RETURN].

Screen icons

AD	Audio Description
S	Programmes with subtitles
SL	Programmes with sign language
HD	High definition programmes
SD	Standard definition programmes
SD>HD	HD simulcast programmes
Pay	Pay-per-view programmes
Guidance	Programmes with guidance information
	Series programmes
*1	Programmes set for single timer recording
*1	Programmes set for series timer recording
*2	Catch Up Programmes

*1 The icon turns grey when the timer is cancelled.

*2 This function can be used when this unit is connected to a network, and it will be made available through a firmware update.

Recording TV programmes

The titles can only be recorded to built-in HDD and cannot be copied from built-in HDD to the media other than USB HDD.



- This unit can record two programmes being broadcasted at the same time.

1 Select the channel to record.

2 Press [REC MODE] and select the conversion mode, then press [OK].

- This unit will record the programmes in DR mode once, and then automatically convert to the selected recording mode while this unit is in standby.
- Recording mode (⇒ 8)

Conversion Mode Setting		Data Size	
HDD Remain	○ h	○ m (DR)	
Off (DR)			
High Definition	HG	Large ↑ ↓ Small	
	HX		
	HE		
	HL		
	HM		
Standard Definition	XP	Large ↑ ↓ Small	
	SP		
	LP		
	EP		

- The conversion mode set here is used as an initial value for the next recording.

3 Press [REC ●].
Recording will start.

4 Select "Automatic Stop", then press [OK].

- **One touch recording (OTR)**

Recording stops automatically when the programme ends.

REC1/OTR	
○○○○ 8:00 - 8:45	
Vacation	
Automatic Stop (Guide Link) at 8:45	
Recording Time	30 min
Continuous recording	

To set the recording time

- 1 Select "Recording Time" or "Continuous recording" in step 4 (⇒ left).

Recording Time:

You can set the length of recording time from 30 minutes to 4 hours.

- You can select the recording time with [◀, ▶].

- 2 Press [OK].

To convert the recording mode after recording in DR mode

Refer to "File Conversion". (⇒ 38)

To confirm whether the conversion is completed

Refer to "To confirm whether the conversion is completed". (⇒ 39)

To cancel a conversion

Refer to "To cancel a "During standby" conversion". (⇒ 39)



- If a timer recording reaches its start time when all tuners are being used for recording, the recording (OTR) of one of the programmes terminates.
- Digital teletext will not be recorded.
- Following contents or media cannot be played back while recording.
 - video file
 - photo
 - USB HDD (For data files, ⇒ 8) and USB memory
- Copying cannot be performed while recording.
- When "Automatic Standby after OTR" is set to "On" (⇒ 64), this unit is turned to standby mode if this unit is not operated for approximately 5 minutes after completing "Automatic Stop" or "Recording Time".

Operation during Recording

To check the recording programme

Press [STATUS .

e.g., While recording two programmes simultaneously

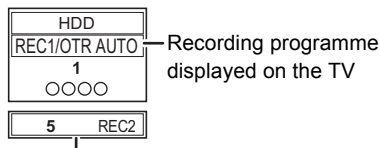

Recording programme not displayed on the TV

To stop recording

Press [STOP .

When recording one programme:

If the following screen appears

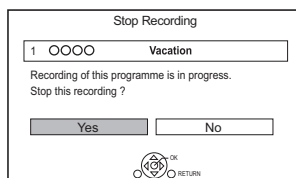

Select "Yes", then press [OK].

When recording two programmes:

Following screen appears

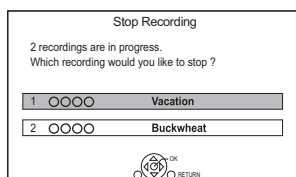

- 1 Select the programme, then press [OK].
- 2 Select "Yes", then press [OK].

To pause recording

After displaying the recording programme, press [PAUSE .

- Press again to restart recording.
(A title is not split into separate titles.)



- Timer recording programme cannot be paused.

To record two programmes simultaneously

While recording, perform steps 1–4 on page 24.



- Channel can only be switched between the recording programmes.

Simultaneous rec and play

You can play the recording title from the beginning or the titles previously recorded to the HDD.

- 1 Press [VIDEO MENU].

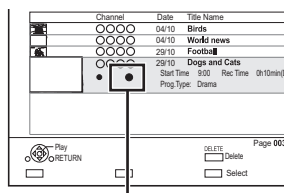

"●" (red) is displayed on the recording programme.

- 2 Select the title, then press [OK].

Notes for Conversion

- The title before conversion (the title recorded in DR mode) will be deleted once the conversion is completed.
- Conversion will take about the same time as the recorded duration.
- When the HDD does not have enough remaining space, conversion will not start.
- Conversion is stopped when this unit is turned on. Conversion will start from the beginning again once the unit is switched to standby mode.
- When converted, audio content and subtitle will be converted with the same settings as at the start of recording.

Timer recording



- You can enter up to 32 programmes within a month in advance. (Each daily or weekly programme is counted as one programme.)
- This unit can record two programmes being broadcasted at the same time.

Preparation

If you want to change the recording mode: Press [REC MODE] and select the recording mode, then press [OK].

- 1 Press [GUIDE].**
TV Guide screen appears.
- 2 Select the programme, then press the [REC ●].**
The timer icon “⊖” (red) is displayed.
 - If on-screen instructions are displayed, follow them.



- This unit has several functions that enable timer recordings to be controlled by the signal sent from the broadcaster. (⇒ 27) If the signal is not sent correctly, the recording may lack the beginning or the ending part of the programmes.
- Some broadcasters may not send programme information. When programme information is not displayed correctly, use manual timer recording. (⇒ 28)
- If the unit cannot record the selected programme, the unit will record the repeat programme if it is available. However, this unit will not record the repeat programme, if any part of the selected programme is recorded.

To use TV Guide (⇒ 22)

Operation during Recording (⇒ 25)

To edit the timer recording on the TV Guide screen

- 1 Select the programme to edit, then press the [OK] or [STATUS ⓘ].
- 2 Select “Edit Recording”, then press [OK].
- 3 Go to step 3 on page 28, “Manually programming timer recording”.
 - Some options cannot be changed when “Guide Link” is effective. (⇒ 27, 29)

To cancel a timer recording on the TV Guide screen

Select the programme to cancel, then press the [REC ●].

If the screen for selecting single or series timer recording appears

Select “Single Timer Recording” or “Series Timer Recording” (⇒ 27), then press [OK].

If “Overlapped Timer Recording” screen appears

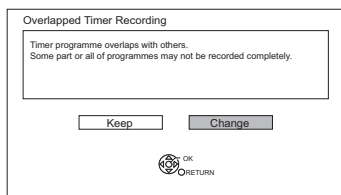

You can eliminate the overlapping or may change with repeat event for the duplicated programme.

- 1 Select “Change”, then press [OK].
- 2 Follow the on-screen instructions.

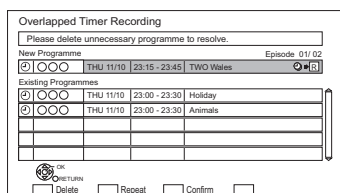

- Red: Delete
 Green: Record repeat programme
 Yellow: Exit (Overlapping is not resolved)

Various functions with Freeview

Guide Link

The recording's start and stop times can be controlled by the broadcaster, e.g. delayed start.

- This is indicated by “Guide Link” in the Timer Recording screen (⇒ 29).
- The “Guide Link” function may not work if you manually change the start time or the stop time over 10 minutes.

Series Timer Recording

You can record all the episodes of a series by setting just one timer recording.

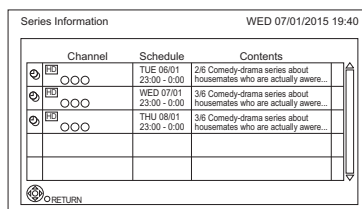

- ☉ Programme for which you set the timer recording
- 🕒 Series Timer Recording programme
- R** Repeat programme
- HD** High definition programme



- Titles recorded using “Series Timer Recording” are bundled and displayed as a “group” in the Video Menu screen (⇒ 31).
- The series recording will be cancelled if there has been no episode of the series for 13 weeks.

Timer recording

Recording recommended programme

You can record a programme that the broadcaster recommends.

- On the TV Guide screen:
Select "Recommended", then press [OK].

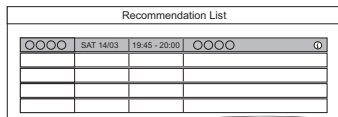

- Select the programme, then press [OK].
 - If the screen for selecting single or series timer recording, or "Programme Selection" screen appears, refer to page 26.
- Press [OK].
The timer icon (red) is displayed on the Recommendation List.
 - To exit from the screen
Press [EXIT ⊗].

To cancel the timer recording on the Recommendation List

- Select the programme with the timer icon (red), then press [OK].
- Select "Yes", then press [OK].
(The timer icon disappears.)



- "Recommended" cannot be selected if there is no recommended programme.

Manually programming timer recording

- Press [PROG/CHECK].

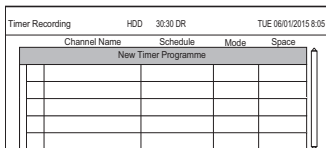

- Select "New Timer Programme", then press [OK].
- Select the items and change the items.
(⇒ 29, Timer recording options)
- Press [OK].
The timer programme is stored.

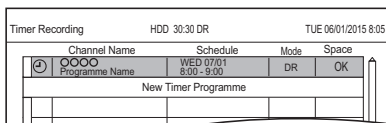

To confirm and edit the timer programme

Refer to "To confirm and edit a timer programme".
(⇒ 30)

Operation during Recording

Refer to "Operation during Recording". (⇒ 25)

Timer recording options

Select the items and change the settings.

e.g.,

Channel	Day/Date	Start	Stop	Mode	Conv.	Subtitles
1	WED 07/01	8:00	9:00	DR	OFF	OFF

Channel

- You can select Category with the red button.

Day/Date

- You can select "Date" or "Weekly" by pressing the green button.

Auto Renewal Recording

- (Only daily/weekly/series timer recording)
The unit will record the new programme over the old one.

Press the yellow button.

"Renew : ON" is displayed.

Start/Stop

- Press and hold [▲, ▼] to alter in 15-minute increments.

Mode/Conv.

Refer to step 2. (⇒ 24)

Subtitles

You can choose whether or not to record the subtitle at conversion.

(Only when item other than "OFF" is selected in "Conv.")

Title Name

- Select "Title Name", then press [OK].
- Refer to "Entering text". (⇒ 67)

Timer recording from channel information

You can make timer recording of the current or next programme.

- While watching a programme
Press [STATUS Ⓞ].

e.g.,

- Display the channel information of a programme to record.
 - Switch the programme with [◀, ▶].
 - Switch the channel with [▲, ▼].
- Press the yellow button.
- Go to step 3 on page 28, "Manually programming timer recording".
 - Some options cannot be changed when "Guide Link" is effective. (⇒ 27, Guide Link)

Notes on timer recording

- When the programme recorded in DR mode is converted, the audio content and subtitle language will be selected according to the following settings:
 - "Multi Audio" and "Audio Description" of "Preferred Multi Audio" (⇒ 58)
 - "Subtitles" of "Preferred Subtitles" (⇒ 58)
- When you programme successive timer recordings to start, about last 1 minute of earlier programme will not be recorded.
- Timer recording will not start while:
 - converting a title in "File Conversion" (Only when "Now" is selected)
 - copying HD Video (AVCHD) from USB device
 - copying video/photos/music files
 - formatting

Timer recording

To confirm and edit a timer programme

1 Press [PROG/CHECK].

e.g.,

Timer Recording		HDD	30:30 DR	TUE 06/01/2015 8:05	
Channel Name	Schedule	Mode	Spaces		
World news	MON 13:01 11:50 - 11:45	DR	<input type="checkbox"/>	<input type="checkbox"/>	OK
Football	MON 13:01 10:00 - 11:50	→HG	<input type="checkbox"/>	<input type="checkbox"/>	OK
Star	MON 13:01 11:38 - 1:00	DR	<input checked="" type="checkbox"/>	<input type="checkbox"/>	I
Dogs and Cats	TUE 07:01 8:50 - 10:45	DR	<input checked="" type="checkbox"/>	<input type="checkbox"/>	
New Timer Programme					
Total 3/32					
		<input type="checkbox"/>	<input type="checkbox"/>	<input type="checkbox"/>	

2 Select the programme, then perform the operations.

To deactivate a timer programme

Press the red button.

- The timer icon “⊖” will change from red to grey.
- Press the red button again to activate timer recording standby. (The timer icon “⊖” will change to red.)

To delete a timer programme

Press [DELETE].

To resolve an overlap timer programme

Press the green button.

- The overlapped timer recording list will appear. (⇒ 27)

To edit a timer programme

- 1 Press [OK].
- 2 Change the timer recording options.
 - Refer to “Timer recording options”. (⇒ 29)
- 3 Press [OK].

To show programme information

Press [STATUS].

To exit the timer recording list

Press [EXIT].



- “No Data” is displayed on a series recording item if there will be no episode of the series for the next 8 days. We recommend you delete the “No Data” item after you confirm the last episode of the series is recorded.

Screen icons

- Red: Timer recording standby is activated.
- Grey: Timer recording standby is deactivated.

- (Red) Currently recording programme

- A part or all of the programme will not be recorded since the programme is overlapping.

- The HDD is full.

- Copy-protected programme
It was not recorded.

- The recording of the programme was not completed because of some reason.

- Auto Renewal Recording is set (⇒ 29).

- Guide Link (⇒ 27)

- Split Programme

- Series Timer Recording (⇒ 27)

- OK Displayed if the recording can fit in the remaining space

- > Daily or weekly timer programme is set.

- (Date) • The timer remains active until the date indicated below -->.

- ! It may not be possible to record because:
 - there is not enough space left.
 - the number of possible titles has reached its maximum. (⇒ 7)
 - programmes are deactivated, etc.

Playing titles on the HDD



* "For recorded titles (⇒ 8)" only

- 1 Press [FUNCTION MENU].
- 2 Select "Contents on HDD", then press [OK].

e.g.,



- 3 To play recorded titles: Select "Recorded Programmes", then press [OK].
The Video Menu screen appears (⇒ below).

To play HD Video (AVCHD):
Select "Video (AVCHD)", then press [OK].
The AVCHD tab appears on the Video Menu screen (⇒ below).

To play video files:
Select "Video (MP4 / Xvid / MKV)", then press [OK].
The video list screen appears (⇒ 32).

- 4 Select the title, then press [OK].

- 1 Tab (⇒ 32)
 - 2 Programme type
 - 3 AVCHD tab
- [USB HDD] When connecting registered USB HDD, "USB HDD" tab and registration number appears. Select "USB HDD" tab.

e.g.,

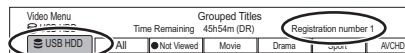

Screen icons

- (Red) Currently recording programme
- Protected title
- Title was not recorded due to recording protection
- Title cannot be played (When data is damaged etc.)
- Grouped titles
- (Blue) Title has not yet been played
- Title is recorded using a different encoding system from that of the unit. Change the "TV System" (⇒ 61).
-
- Radio programme
- 3D contents
- Recorded in 1080/50p contents
- Recorded in 1080/60p contents
- This icon is displayed with the following titles when "Child Lock" is set to "On". (⇒ 58)
 - Title with Guidance information
 - Title restricted by Child Lock List (⇒ 58)
 - PIN is required to play.
- Title has been recorded in Series timer recording.
- Title has been recorded in Series timer recording and has not yet been played.
- Recording did not complete as the timer recording has started.
- Title cannot be played from DLNA client not compatible with DTCP-IP (⇒ 47)

Video Menu screen

e.g.,

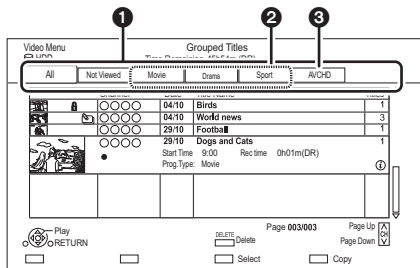

Playing titles on the HDD

Tab

You can quickly find the recorded titles by selecting the tab.

To select the tab

Press [◀, ▶].

To change the displayed programme type tab

- 1 Select the programme type, then press the green button.
- 2 Select the item, then press [OK].

Showing Information

Select the title, then press [STATUS ⓘ].

Showing grouped titles

- 1 Press [OPTION].
- 2 Select "Grouped Titles" or "All Titles", then press [OK].

Grouped Titles:

- Two or more titles recorded in the daily/weekly/series timer recording mode are bundled and displayed as one item.

All Titles

Playing back grouped titles

- 1 On the Grouped Titles screen: Select the item marked with .

2 When playing all titles:

Press [PLAY/× 1.3 ▶].

When playing the individual title:

Press [OK] and select the title, then press [OK].

Editing the grouped titles

- 1 Select the title or the group, then press the yellow button.
 - A check mark is displayed. Repeat this step.
 - Press the yellow button again to cancel.
- 2 Press [OPTION].
- 3 Select the item, then press [OK].

Create Group:

Selected titles are bundled to form a group.

Release Grouping:

All the titles in the group are released.

Remove:

Selected titles are removed from the group.

Playback from Chapter View

- 1 Select the title, then press [OPTION].
- 2 Select "Chapter View", then press [OK].

e.g., 

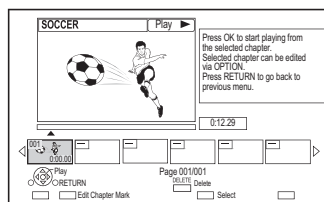

- 3 Select the chapter, then press [OK].

To edit the chapter in Chapter View

Refer to "Editing chapters". (⇒ 39)

Video list screen

e.g.,

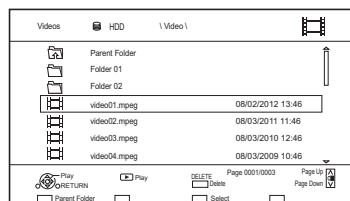

Screen icons

 Folder

 Titles

 Titles (4K)

 Move to the parent folder



- When the following conditions are met, videos are played back in 4K regardless of the image quality:
 - When this unit is connected to a TV that is 4K and 24p/25p compatible
 - When "HDMI Video Format" is set to "Automatic" (⇒ 61)
 - When "24p / 25p Conversion" is set to "Auto" (⇒ 56)
- This unit can not output 4K image when playing back in 3D.

Playing titles on the media



* "For data files (⇒ 8)" only

- 1 Insert the media.**
 - AVCHD: If the menu screen is not displayed
Press [PLAY/× 1.3 ▶].
- 2** When the Video Menu screen or menu screen etc., appears:
Select the item or title, then press [OK].
 - Repeat this step if necessary.

Menu screen

Selecting screen for each operation is displayed when the media is inserted, and you can access the operation screen easily.

e.g., **USB**

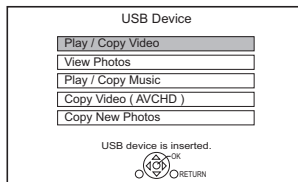

- Display items differ depending on what is recorded in each media.

If the menu screen is not displayed, display it by performing the following operation.

- 1 While stopped
Press [FUNCTION MENU].
- 2 Select "Media", then press [OK].
- 3 Select the media, then press [OK].



- When the following conditions are met, videos are played back in 4K regardless of the image quality:
 - When this unit is connected to a TV that is 4K and 24p/25p compatible
 - When "HDMI Video Format" is set to "Automatic" (⇒ 61)
 - When "24p / 25p Conversion" is set to "Auto" (⇒ 56)
- This unit can not output 4K image when playing back in 3D.

Video list screen

e.g.,

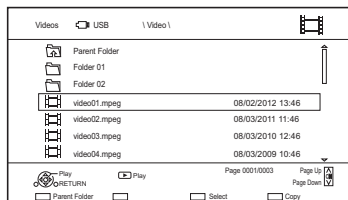

About screen icons (⇒ 32)

Operation during play



General operations

Status messages

Press [STATUS ] twice.

e.g.,

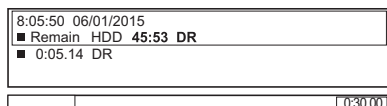

Stop

Press [STOP ].

Resume play function

Press [PLAY/× 1.3 ] to restart from the stopped position.

Quick View



Press and hold [PLAY/× 1.3 ].

- Press again to return to normal speed.



- **Xvid, MKV, MP4 and MPEG2:** Quick View is not effective.

Search

Press [SLOW/SEARCH ] or [SLOW/SEARCH ].

- Press [PLAY/× 1.3 ] to restart play.



- The speed increases up to 5 steps.
- **Xvid, MKV, MP4 and MPEG2:** Audio is not heard during all levels search.

Pause

Press [PAUSE ].

- Press [PLAY/× 1.3 ] to restart play.

Slow-motion

While paused, press [SLOW/SEARCH ] or [SLOW/SEARCH ].

- Press [PLAY/× 1.3 ] to restart play.



- The speed increases up to 5 steps.
- **Xvid, MKV, MP4 and MPEG2:** Slow-motion is not effective.

Frame-by-frame

While paused, press [] () or [] ().

- Each press shows the next frame.
- Press and hold to change in succession forward or backward.
- Press [PLAY/× 1.3 ] to restart play.



- **Xvid, MKV, MP4 and MPEG2:** Frame-by-frame is not effective.

Manual Skip

Skip forward 1 minute:

Press [MANUAL SKIP +60s].

Skip backward 10 seconds:

Press [MANUAL SKIP -10s].



- **Xvid and MKV:** Manual Skip is not effective.

Skipping the specified time

- 1 Press [TIME SLIP].
- 2 Select the time with [**▲**, **▼**].
 - Press and hold [**▲**, **▼**] to change the time by 10-minute.
- 3 Press [OK].
 - Play skips the specified time.



- Xvid, MKV, AVCHD, MP4 and MPEG2: [TIME SLIP] is not effective.

Skipping the title or chapter

Press [SKIP **◀◀**] or [SKIP **▶▶**].



- **HDD** **USB HDD** (For recorded titles, ⇒ 8): It will not skip the title. But the title in the grouped titles will be skipped. (⇒ 32)

To create Chapter Marks

HDD **USB HDD** (For recorded titles, ⇒ 8)

During the playback or pause
Press [CHAPTER].

To delete the Chapter Mark

HDD **USB HDD** (For recorded titles, ⇒ 8)

- 1 While paused
Press [SKIP **◀◀**] or [SKIP **▶▶**] and skip to the location you want to delete.
- 2 Press [CHAPTER].
- 3 Select "Yes", then press [OK].

Changing audio

Select the desired audio with "Multi Audio" in the Basic Operation menu (⇒ 55).

Switching subtitles

HDD **USB HDD** (For recorded titles, ⇒ 8)

- 1 Press [STTL **⊕⊖**].
- 2 Press [OK].
- 3 Select "On" or "Off", then press [OK].
 - If you want to switch the subtitle language, select it in the Basic Operation menu (⇒ 55).

Xvid and MKV:

Display with "Subtitle Settings" in the Basic Operation menu (⇒ 55).

Listening to the Audio Description

HDD **USB HDD** (For recorded titles, ⇒ 8)

- 1 Press [AD].
- 2 Select "Audio Description" and set to "Automatic".
- 3 Select "Volume", then adjust the volume with [**◀**, **▶**].



- When "Dolby Digital / Dolby Digital Plus", "MPEG" or "HE-AAC" is set to "Bitstream", the Audio Description may not work. Set them to "PCM" (⇒ 60, Digital Audio Output).
- You can also set "Audio Description" active in the Setup menu. (⇒ 58)

Aspect

You can switch the aspect ratio of the screen.
(⇒ 67)

Operation during play

3D video playback

Preparation

Connect 3D compatible TV to this unit. (⇒ 12)

- Perform the necessary preparations for the TV.

Play back following the instructions displayed on the screen.

Preparatory 3D settings

3D Type

If 3D video cannot be played back in 3D, you may be able to play it in 3D by changing the setting.

(⇒ 61)

3D AVCHD Output

If 2D AVCHD video is recognised as 3D video and cannot be played back correctly, you may be able to play it by changing the setting. (⇒ 61)

3D Playback Message

Hide the 3D viewing warning screen. (⇒ 61)

3D settings during playback

Change this setting when the screen is not correctly displayed for 3D compatible programmes.

- 1 Press [OPTION].
- 2 Select "Playback Settings" in "Playback Menu", then press [OK].
- 3 Select "3D Settings", then press [OK].
- 4 Select the item, then press [OK].

Signal Format

- Original:
Keep original picture format.
- Side by side:
3D picture format comprising of left and right screens.
- 2D to 3D:
Converts 2D pictures to 3D effect while playing.

3D Picture Mode

- Normal
- Soft
 - This function cannot be enabled when "Signal Format" is set to "2D to 3D".
- Manual:
3D effects set manually (⇒ below)

Manual Settings

(To change the setting, set "3D Picture Mode" to "Manual".)

Distance

Set the amount of depth perception.

Screen Type

Selects how the screen appears during 3D playback (flat or round).

Frame Width

Set the amount of feathering at the edge of screen.

Frame Colour

Set the colour of feathering at the edge of screen.

Graphic Display Level

Adjust the 3D position for the playback menu or message screen etc.



- Please refrain from viewing 3D images if you do not feel well or are experiencing visual fatigue.
In the event that you experience dizziness, nausea, or other discomfort while viewing 3D images, discontinue use and rest your eyes.
- Depending on the connected TV, the video being played back might switch to 2D video due to changes in resolution etc. Check the 3D setting on the TV.
- 3D video might not output the way it is set in "HDMI Video Format" (⇒ 61).
- It may display as Side-by-Side (2 screen structure) when playback of the 3D video is started. Select "Side by side" in "Signal Format". (⇒ left)
- This unit only guarantees the playback of the Frame Sequential and the Side-by-Side (Half) programme types.

Deleting/Editing titles

Once deleted, divided or partially deleted, content cannot be restored to its original state. Make certain before proceeding.



* “For recorded titles (⇒ 8)” only



• PIN is required to edit the titles with **G** in some functions. (⇒ 31)

Deleting recorded titles

- 1 On the Video Menu screen:
Select the title.

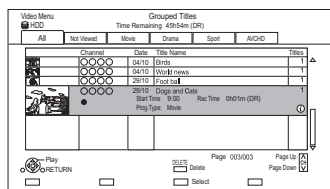

- 2 Press [DELETE].
- 3 Select “Delete”, then press [OK].

Multiple selection

Select the title, then press the yellow button. A check mark is displayed. Repeat this step.
• Press the yellow button again to cancel.

Deleting during play

- 1 Press [DELETE] while playing.
- 2 Select “Delete”, then press [OK].

Editing recorded titles

- 1 On the Video Menu screen: Select the title.
• Multiple selection (⇒ left)
- 2 Press [OPTION].
- 3 Select the item, then press [OK].
e.g.,

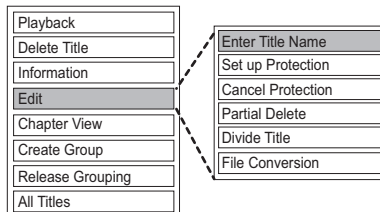

Entering title name

- 1 Select “Enter Title Name” in “Edit”, then press [OK].
- 2 Refer to “Entering text”. (⇒ 67)

Setting protection

Protection setting prevents the title from accidental deletion.

- 1 Select “Set up Protection” or “Cancel Protection” in “Edit”, then press [OK].
- 2 Select “Yes”, then press [OK].
A lock icon appears when setting the protection.

Partial deleting

- 1 Select “Partial Delete” in “Edit”, then press [OK].
- 2 Press [OK] at the start point and end point to delete.
• You can find the desired point by using play, search, etc. (⇒ 34)
- 3 Select “Continue”, then press [OK].
• Select “Next”, then press [OK] to delete other sections. Up to 20 sections can be set. (⇒ go to step 2)
- 4 Select “Delete”, then press [OK].
- 5 Press [BACK/RETURN ⊖].



• Chapter Mark is generated in the scene that was partially deleted.

Deleting/Editing titles

Dividing title

- 1 Select "Divide Title" in "Edit", then press [OK].
- 2 Press [OK] at the point to divide the title.
 - You can find the desired point by using play, search, etc. (⇒ 34)
- 3 Select "Continue", then press [OK].
- 4 Select "Divide", then press [OK].

To confirm the division point

After performing step 2.

Select "Preview", then press [OK].

- The unit plays 10 seconds before and after the division point.

To change the division point

After performing step 2.

Restart play and select "Divide", then press [OK] at the division point.



- Divided titles will become a group of titles.

File Conversion

File Conversion is a function to convert the recording mode of the title in DR mode and AVCHD contents. The size of the converted title will be small regularly. It will take about the same time as the recorded duration.

- 1 Select "File Conversion" in "Edit", then press [OK].
e.g.,

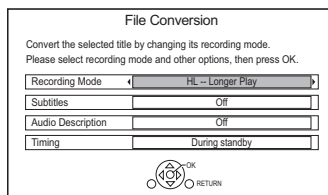

- 2 Set the conversion options, then press [OK].

Recording Mode (⇒ 8):

- **USB HDD** You cannot select XP, SP, LP and EP mode.

Subtitles:

- **Automatic**
Subtitles will be recorded if they are included in the title.
- **Off**
Subtitle will not be recorded.

Audio Description:

- **Automatic**
Audio Description will be recorded if they are included in the title, and will not be recorded if they are not included.
- **Off**
Audio Description will not be recorded.

Timing:

- **Now**
Conversion begins immediately after step 4.
 - Timer recording will not be performed during conversion.
- **During standby**
Conversion will be performed after the unit is switched to standby mode.

- 3 Select the item, then press [OK].

Convert & Delete:

The original title will be deleted to save HDD capacity after conversion.

Convert Only:

The original title remains after conversion.

- When converting to HG, HX, HE, HL or HM mode, if the selected title is copyrighted, you cannot select "Convert Only".

- 4 **"Now" conversion:**

Select "Start", then press [OK].

"During standby" conversion:

Press [OK].

- Conversion will be performed after the unit is switched to standby mode.

To cancel a "Now" conversion

Press and hold [BACK/RETURN] for more than 3 seconds.

To confirm whether the conversion is completed

Press [VIDEO MENU].

e.g.,

Channel	Date	Title Name	Titles
○○○○	04/10	Birds	1
○○○○	04/10	World news	1
○○○○	29/10	Football	1
○○○○	29/10	Dogs and Cats	1
●	Start Time: 9:00	Rec. tm: 1h00m(DR→HL)	①
	Prog. Type: Movie		

When “○○ → ○○ (Recording mode for conversion)” is displayed, the conversion has not finished.

To cancel a “During standby” conversion

After performing steps 1–2 (⇒ 37, Editing recorded titles)

- 1 Select “File Conversion” in “Edit”, then press [OK].
- 2 Select “Yes”, then press [OK].



- To use “File Conversion”, the HDD needs enough storage capacity.
- File Conversion is stopped when this unit is turned on during performing “During standby” conversion. Conversion will start from the beginning again once the unit is switched to standby mode.
- When converted, the audio content and subtitle language will be selected according to the following settings:
 - “Multi Audio” of “Preferred Multi Audio” (⇒ 58)
 - “Subtitles” of “Preferred Subtitles” (⇒ 58)
- When converted, 3D information may not be retained.

Editing chapters

- 1 Select “Chapter View”, then press [OK].
- 2 Perform the editing operations.

Edit Chapter Mark:

Select the point where you want to start a new chapter while viewing the title.

- 1 Press the green button.
- 2 Press [OK] at the point you want to divide.
 - Repeat this step.
- 3 Press [BACK/RETURN ⊖] to go to Chapter View screen.

To delete the chapter:

- 1 Select the chapter, then press [DELETE].
 - Multiple selection (⇒ 37)
- 2 Select “Delete”, then press [OK].

To combine chapters (Delete chapter mark):

- 1 Select the chapter, then press [OPTION].
- 2 Select “Combine Chapters”, then press [OK].
- 3 Select “Combine”, then press [OK].

The selected chapter is combined to the next chapter.

Playback from Chapter View

Refer to “Playback from Chapter View”. (⇒ 32)



- The maximum number of chapters: (Depends on the state of recording.)
Approx. 1000 per title
- When the title has the maximum number of chapters, you cannot perform the Resume play function (⇒ 34) with the title.

Deleting video files on the HDD

HDD

- 1 On the video list screen:
Select the file or folder.

e.g.,

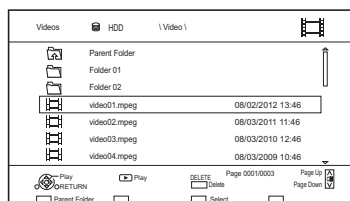

- Multiple selection (⇒ 37)
- 2 Press [DELETE].
 - 3 Select “Yes”, then press [OK].



- All files in the folder will be deleted.

Copying titles



- ※1 “For recorded titles (⇒ 8)” only
- ※2 The title in the source media will be deleted.
- ※3 The recording mode cannot be changed.

- 1** Connect the USB HDD.
- 2** Press [FUNCTION MENU].
- 3** Select “Recorded Programmes” in “Contents on HDD”, then press [OK].
- 4** Select the title.
 - **Multiple selection**
Select the title, then press the yellow button.
A check mark is displayed. Repeat this step.
 - Press the yellow button again to cancel.
- 5** Press the blue button.
- 6** Select “Yes”, then press [OK].
 - If you select “No”, you can change the selection. (⇒ right, To change the selection)
- 7** Set other settings, then press [OK].
e.g.,

Automatic Standby after Copy Off

Standby status can be changed if required.
Please press OK to start copying.

 (⇒ right, Setting the copying options)
- 8** Select “Yes”, then press [OK].

To register the external HDD (USB HDD)
(⇒ 53)

To copy video files (⇒ right)

To change the selection

- 1** Select “No”, then press [OK] in step 6 (⇒ left).
- 2** Select the title, then press the yellow button.
Repeat this step to select titles.
- 3** Press the blue button.
- 4** Go to step 6 (⇒ left).

About screen icons on the Video Menu

Refer to “Screen icons”. (⇒ 31)

Setting the copying options

- 1** Select the item in step 7 (⇒ left).
- 2** Press [◀, ▶] to change the settings.
 - **Automatic Standby after Copy On:**
This unit is turned to standby mode when it is not operated for approximately 5 minutes after completing copy.

Copying video files



- 1** On the video list screen: Select the file or folder.

e.g.,

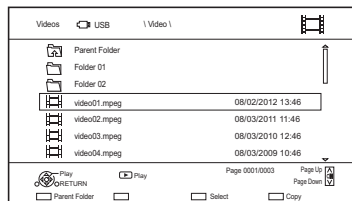

- Multiple selection (⇒ left)
- 2** Press the blue button.
 - 3** Select “Yes”, then press [OK].

To stop copying

Press and hold [BACK/RETURN] for 3 seconds.



- All files in the folder will be copied.
- The names of folders/files cannot be changed after they are copied to the HDD. We recommend that you create a folder with an easily identifiable name on a PC or other device first and use the folder to perform copying.
- Up to 1000 files can be copied at once.
- While copying, no other operations can be performed. Timer recordings will not proceed.

Playing photos



* "For data files (⇒ 8)" only (JPEG, MPO)

- 1** **HDD**
 - 1 Press [FUNCTION MENU].
 - 2 Select "Photo" in "Contents on HDD", then press [OK].

Except **HDD**

 - 1 Insert or connect the media.
The menu screen appears. (⇒ 33)
 - 2 Select "View Photos", then press [OK].
- 2** Select the folder, then press [OK].
- 3** Select the photo, then press [OK].
 - Press [◀, ▶] to display the previous or next photo.



- When the following conditions are met, photos are played back in 4K regardless of the image quality:
 - When this unit is connected to a TV that is 4K and 30p compatible
 - When "HDMI Video Format" is set to "Automatic" (⇒ 61)
 This unit can not output 4K image when playing back in 3D.

Photo Menu screen

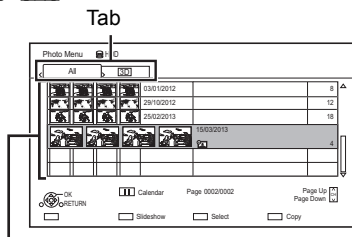

e.g., **HDD**



Photos imported to the HDD (⇒ 44) are managed using folders. Folders and photos can be edited by pressing [OPTION]. (⇒ 43)

- **To select the tab**
Press [◀, ▶].
- **To start Slideshow**
Refer to "Slideshow settings". (⇒ 42)
- **HDD**
To display or exit the Calendar screen
Press [PAUSE ■■■].

Screen icons

- 3D (Tab)**
3D photos (MPO)
 - Select from this tab to play back in 3D.
-  Photo protected
-  New photo which is not viewed

Playing photos

Photo play option

- 1 While displaying a photo:
Press [OPTION].
- 2 Select the item, then press [OK].

Graphic Display Level

You can change the 3D position of the screen display, etc., during the 3D photo playback.

Photo Menu

• Start Slideshow

You can start a slideshow.

• Rotate RIGHT/Rotate LEFT

- The information of the rotated photos will not be stored depending on the media.
- This function is not available during the 3D photo playback.

• Information

Information (shooting date etc.) is shown.

• Wallpaper

A photo being played back is registered as wallpaper on the FUNCTION MENU screen. (⇒ 18)

Slideshow settings

- 1 On the Photo Menu screen:
Press the green button.

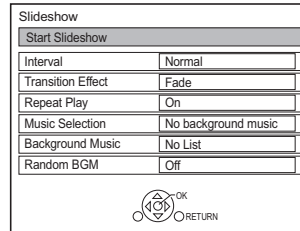

- 2 Select the item, then press [OK].

Start Slideshow

Interval

Set up the time until the next photo is to display.

Transition Effect*

Effect for the next photo to display can be set.

Repeat Play

Music Selection*

Select background music on (either from HDD or USB) or off.

Background Music*

Select background music from HDD or USB (Folder).

Random BGM*

Play back the BGM (Background Music) in random order.

* This function is not available during the 3D photo playback.

To pause the Slideshow

Press [PAUSE ■■].

- Press [PAUSE ■■] again to restart.

To stop the Slideshow

Press [BACK/RETURN ⊖].

Editing photos



1 On the Photo Menu screen:

To edit the folder:

Select the folder.

To edit the photo:

1 Select the folder, then press [OK].

2 Select the photo to edit.

• **To select multiple folders or photos**

Press the yellow button when selecting the folder or photo.

A check mark is displayed. Repeat this step.

- Press the yellow button again to cancel.

2 Press [OPTION].

- Selectable items will change depending on the type of file.

3 Select the item, then press [OK].

Enter Folder Name

Refer to “Entering text”. (⇒ 67)

Combine Folders

Delete Folder

Move Photos

Select “Move to new folder” or “Move to another folder”, then press [OK].

- If “Move to another folder” is selected, set a destination folder.

Delete Photos

Copying photos



* “For data files (⇒ 8)” only (JPEG, MPO)



- The name of the copied photos will be changed.

Selecting and copying the photos

USB HDD **USB** → **HDD**

- 1 On the Photo Menu screen:
To copy the folder:
 Select the folder, then press the blue button.

To copy the photo:

- 1 Select the folder, then press [OK].
 - 2 Select the photos to copy, then press the blue button.
- **To select multiple folders or photos**
 Press the yellow button when selecting the folder or photo.
 A check mark is displayed. Repeat this step.
 - Press the yellow button again to cancel.

- 2 Select “Yes”, then press [OK].
 Copying starts.

To stop copying

Press and hold [BACK/RETURN 

Copying automatically

USB HDD **USB** → **HDD**

Newly added photos will automatically be copied to the HDD.

- 1 Insert the media.
 The menu screen appears. (⇒ 33)
- 2 Select “Copy New Photos”, then press [OK].
 e.g., **USB**

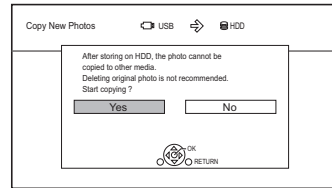

- 3 Select “Yes”, then press [OK].
 Copying starts.
- 4 Once the copy is completed, select “Yes” or “No”, then press [OK].

To stop copying

Press and hold [BACK/RETURN 



- Photos without shooting date will be categorised using the creation date.

Playing music



* "For data files (⇒ 8)" only

Playing music file on the media

USB HDD **USB**

- 1 Insert or connect the media.
The menu screen appears. (⇒ 33)
- 2 Select "Play / Copy Music", then press [OK].
The music list screen appears.

e.g.,

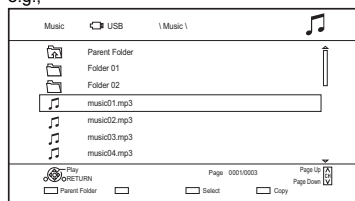

- 3 Select the item, then press [OK].
 - Repeat this step if necessary.
 Playback will start.



- The track/artist/album name will be displayed if the information is contained in music file.

Screen icons

	Folder
	Music
	Move to the parent folder

Playing music file on the HDD

HDD

- 1 Press [FUNCTION MENU].
- 2 Select "Music" in "Contents on HDD", then press [OK].
The music list screen appears.
- 3 Go to step 3 (⇒ above), "Playing music file on the media".

Operations during music play

Stop

Press [STOP ■].

Pause

Press [PAUSE ■■].

- Press [PLAY/×1.3 ▶] to restart play.

Search

Press [SLOW/SEARCH ◀◀] or

[SLOW/SEARCH ▶▶].

- Press [PLAY/×1.3 ▶] to restart play.

Skip

Press [SKIP ◀◀] or [SKIP ▶▶].

Repeat Play/Random

Refer to "Repeat Play" or "Random" in Basic Operation menu (⇒ 55).

Sound Effects

Refer to "Sound Effects" in Sound Settings menu (⇒ 56).

To play music continuously even if the Power off link works

Refer to "Playing music continuously even after turning off power to the TV". (⇒ 54)

Copying/Deleting music



* "For data files (⇒ 8)" only

Copying

USB HDD **USB** → **HDD**

- 1 On the music list screen:
Select the file or folder.

e.g.,

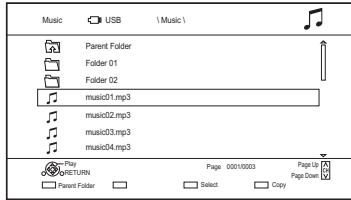

- 2 Press the blue button.
- 3 Select "Yes", then press [OK].

To stop copying

Press and hold [BACK/RETURN ⊕] for 3 seconds.

Multiple selection

Select the file or folder, then press the yellow button.

A check mark ✓ is displayed. Repeat this step.

- Press the yellow button again to cancel.



- While copying, no other operations can be performed.
Timer recordings will not proceed.
- All files in the folder will be copied.
- Up to 1000 files can be copied at once.

Deleting

HDD

- 1 On the music list screen:
Select the file or folder.
• Multiple selection (⇒ left)
- 2 Press [DELETE].
- 3 Select "Yes", then press [OK].



- All files in the folder will be deleted.

Smart Home Networking (DLNA)

Smart Home Networking (DLNA) allows you to watch the contents and broadcasts on Server equipment connected on the same network from Client equipment.

This unit can be used both as Server and Client. Additionally, if used as Client, this unit can also be used as Media Renderer, which can be controlled by a Smartphone, etc.

Preparation

- Perform network connection and settings. (⇒ 13, 16)
- Perform Home Network settings of the DLNA compatible equipment.

For more details, refer to the following website and the operating instructions for each item of equipment.

<http://panasonic.jp/support/global/cs/>
(This site is in English only.)



- Ensure that the router for your home network has adequate security system to prevent unauthorised access.
- If using slow network connection, the video may not be displayed correctly. A high-speed home network with a speed of at least 20 Mbps is recommended.
- Some video or broadcasts cannot be enjoyed depending on the DLNA (Client) compatible equipment, the condition of this unit, or the file type.

Using this unit as Server

You can watch broadcasts received by this unit (Multiroom TV Streaming), videos and photos saved on HDD of this unit on DLNA (Client) compatible equipment.

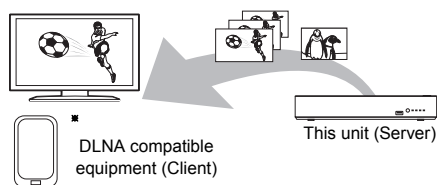

For details regarding the connection and operation of equipment connected via a network, refer to their respective operating instructions.

- * DLNA function compatible software should be installed.

Preparation

- Perform Home Network settings. (⇒ 63)

- 1 Operate the playback equipment (Client) to display the list of contents on this unit.
- 2 Select the item, then press [OK].



- The DLNA compatible device that is to be connected to the unit should be connected to the same hub or broadband router as the unit.
- The titles with access restriction (e.g., copy restriction) signals sent from broadcasters are not available for this function.
- You cannot play back music from the playback equipment (Client).
- If video frames are dropped, change the following settings.
 - Conversion Setting for DLNA (⇒ 63)
 - Resolution Setting for DLNA (⇒ 63)
- Files not on the HDD cannot be played back.
- Playing back 3D video recorded on this unit may not work properly.
- 3D photos copied to this unit cannot be played back in 3D.
- We recommend that you set "Networked Standby" to "Off". (⇒ 64)

Smart Home Networking (DLNA)

Using this unit as Client

You can share videos, photos and music stored in the DLNA Certified media server.

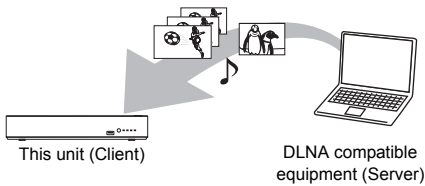

- Playlist of Windows Media® Player can play back only the contents that are stored in the libraries.
- While playing back the 3D programme, you cannot set "3D Settings". (⇒ 36)

- 1 Press [FUNCTION MENU].
- 2 Select "DLNA Client" in "Home Network", then press [OK].
A list of equipment connected via the network is displayed.
 - This list can be updated by pressing the red button.
- 3 Select the equipment, then press [OK].
- 4 Select the item, then press [OK].
 - Menu structure will be different depending on the equipment. Select the contents by repeating the operation.
 - Convenient functions can be used by pressing [OPTION] depending on the contents.
 - **Control Panel**
Control Panel is displayed once the playback starts.
 - Press [OK] if the Control Panel is not displayed. (It may not be displayed depending on the conditions of use.)
 - (While playing video or photo) Press [BACK/RETURN ⊖] to hide the Control Panel.

Playable contents

When this unit works as a DLNA client, following contents are playable.

Video

Container	Video codec	Audio codec	Example of file extension
Recorded programmes (XP/SP/LP/EP/FR) ^{*1}	MPEG2	Dolby® Digital Linear PCM	.mpg .mpeg
Recorded programmes (DR/HG/HX/HE/HL/HM) ^{*1}	MPEG2 H.264	MPEG HE-AAC Dolby® Digital	.m2ts .ts
AVCHD ^{*1}	H.264	Dolby® Digital	.mts
MP4	H.264	AAC	.mp4
MPEG2	MPEG2	Dolby® Digital Linear PCM	.mpg .mpeg
Xvid	H.264	MP3 Dolby® Digital	.avi
MKV	H.264	AAC-LC MP3 Dolby® Digital PCM Vorbis FLAC	.mkv

Photo

Format	Example of file extension
JPEG	.jpg
MPO ^{*1, 2}	.mpo

^{*1} Only when the server is another Panasonic Blu-ray Disc Recorder, etc.

^{*2} 2D playback only.

Audio

Audio codec	Example of file extension
MP3	.mp3
WAV	.wav
AAC	.m4a, .adts
WMA	.wma
FLAC	.flac
Linear PCM	—

• Depending on the server, the contents other than stated above can be played back.

Using this unit as Media Renderer

This unit works as Media Renderer, which allows you to play back the contents on DLNA Server by operating a Digital Media Controller (a smartphone, etc.).

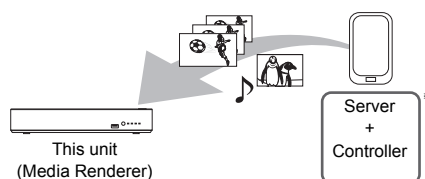
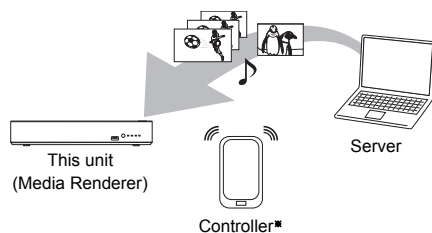

* Digital Media Controller compatible software should be installed.

Following steps are necessary to use this unit as Media Renderer.

- 1** Press [FUNCTION MENU].
- 2** Select "Media Renderer" in "Home Network", then press [OK].
- 3** Operate the Digital Media Controller compatible equipment.

To exit from Home Network (Media Renderer) screen

Press [BACK/RETURN ⊖].

Smart Home Networking (DLNA)

Using Smart Home Networking (DLNA) with Wi-Fi Direct®

Wi-Fi Direct is a standard that enables wireless LAN devices to communicate each other directly without a wireless broadband router.

This unit can be connected wirelessly and directly to other DLNA compatible equipment on a temporary basis, regardless of the network connection and settings of this unit.

Connecting temporarily

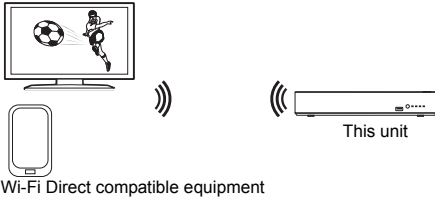

- 1 Press [FUNCTION MENU].
- 2 Select "Wi-Fi Direct" in "Home Network", then press [OK].
- 3 Select the item, then press [OK].
 - Set up the device to be connected so that a Wi-Fi Direct connection can be made. For details, refer to the operating instructions for the device to be connected.
- 4 Select the device to be connected, then press [OK].
 - If the device you want to connect to is not displayed, switch the connection method by pressing the yellow button.
- 5 **When selected "DLNA Client":**
Go to step 4 on page 48.

When selected "DLNA Server":
Operate the playback equipment (Client).

When selected "Media Renderer":
Operate the Digital Media Controller.

When no devices are found

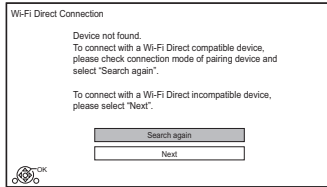

If the corresponding device is not found even after the search is run again, select "Next" and change the connection method.

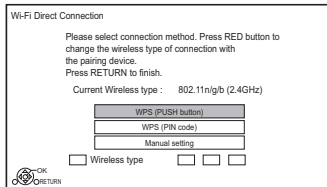

Select the connection method according to the device to be connected.

Using Miracast™

You can enjoy the content you are viewing on a Miracast-compatible smartphone, etc. on the big screen of your TV.

- Compatible with Android™ device, ver. 4.2 and above and Miracast certified.
- For information on whether the smartphone, etc. supports Miracast, contact the manufacturer of the device.

Miracast compatible equipment

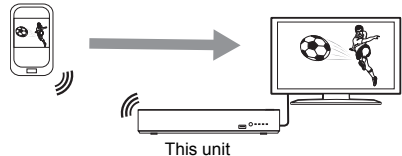

- 1 Press [FUNCTION MENU].
- 2 Select "Miracast" in "Home Network", then press [OK].
- 3 Operate the Miracast compatible equipment.

To exit from Miracast

Press [EXIT ⓧ].

TV Anywhere

You can use the following functions, etc. anywhere using a smartphone, tablet or PC.

- Setting a recording
- Watching TV with this unit's tuner*
- Playing back titles recorded on this unit*

* Not available for PCs.

(You must register to a service to use these functions.)

Smartphone, tablet or PC

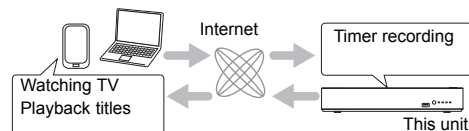

For details, please check the following website.

<http://panasonic.jp/support/global/cs/>

(This site is in English only.)

Preparation

- Perform network connection and settings. (⇒ 13, 16)
- TV Anywhere Settings (⇒ 63)



- This unit will always be connected to the Internet when this function is activated.
- Please note that a regular maintenance or unexpected trouble may interrupt the service, and that the service content may be changed or revoked and operation menu screens may be changed with or without a prior notice.
- We recommend that you use a high-speed connection, such as LTE or Wi-Fi.

Enjoying Network Service

Network Service allows you to access some specific websites supported by Panasonic, and enjoy Internet contents such as photos, videos, etc. from Network Service home screen.

e.g.,

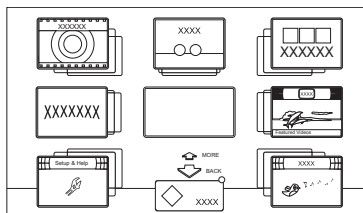

Preparation

- Perform network connection and settings. (⇒ 13, 16)

- 1** Press [NET].
 - When the message is displayed. Please read it carefully and then press [OK].
 - NETFLIX can be accessed directly by pressing [NETFLIX] button.
- 2** Select the item, then press [OK].
 - Operable buttons: [▲, ▼, ◀, ▶], [OK], [BACK/RETURN ⊙], colour buttons and number buttons.

To exit

Press [EXIT ⊗].



- Some features of websites or content of the service may not be available.
- This unit does not support 4K streaming.
- If using slow Internet connection, the video may not be displayed correctly. A high-speed Internet service with a speed of at least 6 Mbps is recommended.
- The services through Network Service are operated by their respective service providers, and service may be discontinued either temporarily or permanently without notice. Therefore, Panasonic will make no warranty for the content or the continuity of the services.
- In the following cases, settings are possible using "Network Service Settings". (⇒ 62)
 - When restricting the use of Network Service.
 - When the audio is distorted.
- A separate subscription is required to watch Netflix.

Copying the HD Video (AVCHD)



* “For data files (⇒ 8)” only

This unit cannot copy the titles in the HDD to the media. Be careful when deleting the original title after copying to the HDD.

e.g., Connecting to the Panasonic video camera

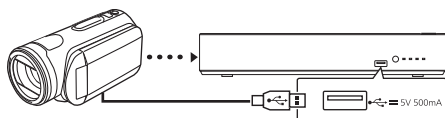

USB connection cable
(optional)

- 1** Connect the video camera or insert the media.
 - Make the video camera ready for data transfer.The menu screen appears. (⇒ 33)
- 2** Select “Copy Video (AVCHD)”, then press [OK].
- 3** Press [OK].
- 4** Select the title, then press the yellow button. A check mark is displayed. Repeat this step.
 - Press the yellow button again to cancel.
(All the recordings on the same date become a title.)
- 5** Press [OK].
- 6** Select “Start”, then press [OK].

To stop copying

Press and hold [BACK/RETURN Ⓢ] for 3 seconds.

Screen icons

- N (NTSC)** Title recorded using a different encoding system from that of the unit.
- P (PAL)**
 - Titles displaying these marks cannot be selected.

Registering the external HDD (USB HDD)



* “For recorded titles (⇒ 8)” only

If you intend to move recorded titles to a USB HDD, the USB HDD must be registered to this unit first.

Limitation information

- A USB HDD with a capacity of less than 160 GB cannot be used.
- Registering of a USB HDD will format the USB HDD and all the content already recorded will be deleted.
- Up to eight USB HDDs can be registered on this unit. If you have already registered eight USB HDDs, it will be necessary to delete one or more of them before registering a new USB HDD.
- Registered USB HDDs cannot be used with devices other than this unit.

Regarding the external HDD (USB HDD)

Please use a confirmed USB HDD.

For the latest information on confirmed USB HDDs, please check the following website.

<http://panasonic.jp/support/global/cs/>

- Certain non-confirmed USB HDDs cannot be used with this unit.
- If a problem occurs with the USB HDD, please contact the manufacturer of the device.

Connecting the USB HDD

Connect this unit with optional USB HDD.

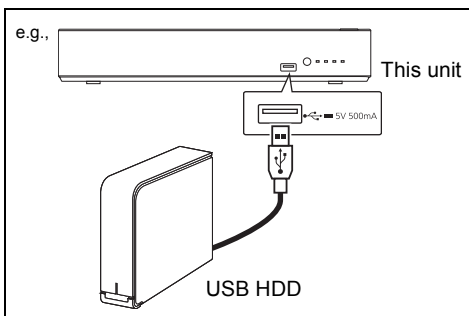

- **HWT250** Only one USB HDD (For recorded titles, ⇒ 8) can be connected at the same time.
- **HWT250** The USB HDD can be connected to the USB port on either the front or rear of this unit.
- Do not connect additional HDDs using a USB hub.
- For details about connection method, refer to the instructions supplied with the USB HDD.

Disconnecting the USB HDD

Disconnecting without following this procedure may result in the loss of recorded content from the USB HDD or the internal HDD.

- 1 Press [FUNCTION MENU].
- 2 Select “Basic Settings” in “Setup”, then press [OK].
- 3 Select “Settings for USB HDD” in “HDD / USB HDD”, then press [OK].
- 4 Select “USB HDD Disconnection”, then press [OK].
- 5 Select “Yes”, then press [OK].
- 6 Disconnect the USB HDD from this unit.

Registering the USB HDD

- If the registering screen appears when connecting the USB HDD, go to step 5.

- 1 Press [FUNCTION MENU].
- 2 Select “Basic Settings” in “Setup”, then press [OK].
- 3 Select “Settings for USB HDD” in “HDD / USB HDD”, then press [OK].
- 4 Select “USB HDD Registration”, then press [OK].
- 5 Select “Yes”, then press [OK].
- 6 When the registering is complete, message screen appears. Press [OK].
- 7 The confirmation screen appears. Press [OK].

To cancel all USB HDD registrations (⇒ 59)



- It is not possible to play back the content on the USB HDD whose registration has been cancelled.
- You can check the registration number of the USB HDD on the Video Menu. (⇒ 31)

VIERA Link functions

What is VIERA Link?

VIERA Link is a convenient function which will link the operations of this unit and a Panasonic TV (VIERA) or an amplifier/receiver. You can use this function by connecting the equipment with the HDMI cable. See the operating instructions for connected equipment.

Automatic input switching/ Power on link

When the following operations are performed, the input channel of the TV will be automatically switched and the screen of this unit will be displayed. Additionally when the TV is off, the TV will automatically turn on.

- When play starts on this unit
- When an action that uses Video Menu etc, is performed

Power off link

When you set the TV to standby mode, this unit is also automatically set to standby mode.

- Power off link function does not work when manual recording, copying etc.

Playing music continuously even after turning off power to the TV

The following operations make it possible to keep the power of the unit on and to play music continuously.

When the unit is directly connected to an amplifier/receiver.

- 1 While playing music
Press [OPTION].
 - 2 Select "TV Power Off", then press [OK].
- Sound may be discontinued for several seconds when the power to the TV is turned off.

Easy control only with Panasonic TV's remote control

You can operate this unit using the TV remote control.

Refer to the operating instructions of the TV about the buttons that you can use.



- VIERA Link, based on the control functions provided by HDMI which is an industry standard known as HDMI CEC (Consumer Electronics Control), is a unique function that we have developed and added. As such, its operation with other manufacturers' equipment that supports HDMI CEC cannot be guaranteed.
- These functions may not work normally depending on the equipment condition.
- Use the remote control supplied with this unit if you cannot operate this unit using buttons on the TV remote control.

Playback menu

A variety of playback operations and settings can be performed from this menu.

Available options differ depending on the playing contents and the condition of the unit.

- 1 Press [OPTION].
- 2 Select "Playback Settings" in "Playback Menu" or select "Playback Settings", then press [OK].

e.g.,

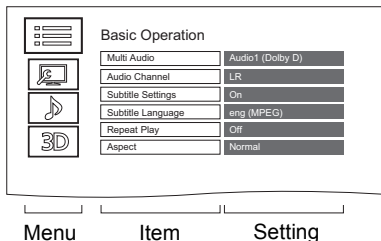

- 3 Select the menu, then press [OK].
- 4 Select the item, then press [OK].
- 5 Change the setting.

To clear the Playback menu

Press [BACK/RETURN ⊖] until the Playback menu disappears.

Language

ENG	English	JPN	Japanese	ARA	Arabic
FRA	French	CHI	Chinese	HIN	Hindi
DEU	German	KOR	Korean	PER	Persian
ITA	Italian	MAL	Malay	IND	Indonesian
ESP	Spanish	VIE	Vietnamese	MRI	Maori
NLD	Dutch	THA	Thai	BUL	Bulgarian
SVE	Swedish	POL	Polish	RUM	Romanian
NOR	Norwegian	CES	Czech	GRE	Greek
DAN	Danish	SLK	Slovak	TUR	Turkish
POR	Portuguese	HUN	Hungarian	*	Others
RUS	Russian	FIN	Finnish		

Basic Operation

Soundtrack

Show or change the soundtrack.

Multi Audio

Switch in the case of multiple audio.

Audio Channel

Change audio (LR/L/R) during playback.

Subtitle Settings

Turn the subtitle on/off, and change the language depending on the media.

Subtitle Language

Select the subtitle language in the case of multiple languages.

Repeat Play

Select the item which you want to repeat.

Random

Select whether to play random or not.

Aspect (⇨ 67)

Reception

The radio wave status during the playback of Smart Home Networking (DLNA) is displayed. (Only when a wireless connection is used)

Playback menu

Picture Settings

Picture Type

Select the picture type.

Sharpness Adjustment

Noise Reduction

Luminance/Colour Adjustment

Bandwidth Limitation

Adjusts the bandwidth limitations.

24p / 25p Conversion

Plays back videos with film-like motion.

- This function is available on the following conditions:
 - “HDMI Video Format” set to “Automatic”, “1080i*” or “1080p*” (⇒ 61)
 - * Only for 24p Conversion
 - Connect 24p/25p compatible TV.
- Noise may appear on the image when you switch the setting.

Progressive

Select the method of conversion for progressive output to suit the type of title being played.

- **Auto**

Automatically detects the film and video content, and appropriately converts it.
- **Video**

Select this setting when the content is distorted if “Auto” is selected.
- **Film**

Select this if the edges of the film content appear jagged or rough when “Auto” is selected. However, if the video content is distorted, then select “Auto”.

Reset to Default Picture Settings

Restores the default settings of the Picture Settings menu.

Sound Settings

Sound Effects

- This function is effective when “Digital Audio Output” is set to “PCM”. (⇒ 60)

Night Surround

Enjoy a movie with powerful sound even when the volume is kept low at night.

Re-master 1-2

Sound becomes more natural by adding higher frequency signals not recorded on the track.

Dialogue Enhancer

The volume of the centre channel is raised to make dialogue easier to hear.

3D Settings (⇒ 36)

Signal Format

3D Picture Mode

Manual Settings

Graphic Display Level



- The menu is not displayed when playing photos.

Basic Settings

You can change the unit's settings of Digital TV Tuning, Sound, Display, Connection, Network etc. in the menu.

- 1 Press [FUNCTION MENU].
- 2 Select "Basic Settings" in "Setup", then press [OK].

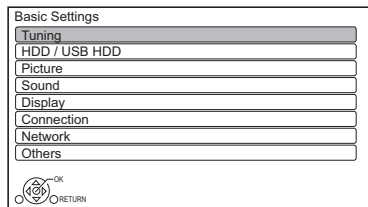

- 3 Select the menu, then press [OK].
- 4 Select the item, then make the setting.

To return to the previous screen

Press [BACK/RETURN ⊖].

Tuning

Favourites Edit

You can create four favourites of channels for making viewing and recording easier.

After editing as follows, save the Favourites.

Press [BACK/RETURN ⊖], then press [OK].

- To select the other Favourites list:
Press the green button.
- To add channels to the Favourites list:
Select the channel in the "All DVB Channels" column, then press [OK]. Repeat this step.
 - Yellow: Add all the available channels to the Favourites. (This function is available only when there are no channels in the "Favourites".)
- To change the order of the channels list:
 - 1 Select the channel in the "Favourites" column to move, then press the green button.
 - 2 Select the new position, then press the green button.

- To delete channels:
Select the channel in the "Favourites" column, then press [OK].
 - Yellow: Delete all channels.
- To change the name of the Favourites list:
 - 1 Press the red button in the "Favourites" column.
 - 2 Press [▲, ▼, ◀, ▶] to select a character, then press [OK].
Repeat this step to enter other characters.
 - Red: Delete a character.
 - Blue: Delete all characters.
 - 3 Press [BACK/RETURN ⊖].

Auto Setup

You can restart the Auto Setup. (⇒ 14)

PIN is required when you have locked channels. (⇒ 58, Child Lock List)

Select "Yes", then press [OK].



- The timer recording programmes are cancelled.
- If you perform "Channel Sorting by Region" (⇒ 58), you can sort the channel list best suited to your region after Auto tuning is finished.

Settings for Channels

Channel List

You can edit the channel list.

- To hide unwanted channels
 - 1 Select the channel.
 - 2 Press [OK].
The check mark is removed.
 - Yellow: Reveal all channels.
- To change the channel number assignment
 - 1 Select the channel to change, then press the green button.
 - 2 Enter the channel number to reassign with the number buttons.
 - 3 Press [OK].
- To set the channel manually
 - 1 Press the red button.
 - 2 Refer to "Manual Tuning". (⇒ 58)

Basic Settings

Channel Sorting by Region

If you want to sort the channel list best suited to your region, follow the on-screen instructions to select the region you live in. Normally, you should select "Best signal quality (All Regions)".

Manual Tuning

You can add new channels manually.

- 1 Press [**▲**, **▼**] to select the frequency.
 - Adjust the frequency by checking the signal strength and signal quality displays.
- 2 Press [OK] to start scan.
 - The set channel is displayed in the table.

Update Channel List

You can update the channel list to the latest one.

Signal Condition

You can check the quality and strength of signals.

Press [CH \wedge \vee] to select the channel.



- The channels you can receive are affected by weather conditions, seasons, time (day/night), region, length of the cable that is connected to the aerial, etc.
- When the signal is too strong (red bar), reduce the signal amplification at your aerial. (For details, consult your dealer.)

New Channel Message

Set whether to obtain the information automatically when a new DVB channel is added.

Child Lock

You can restrict the viewing/playback/recording of channels unsuitable to children.

- PIN is required to change. (⇒ 19)

Child Lock List

- 1 Select the channel to lock.
- 2 Press [OK].
 - **G** is displayed.
 - Press [OK] again to cancel.
 - Green: Lock all channels.
 - Yellow: Unlock all channels.

Player PIN Control

You can restrict the viewing of Digital teletext (MHEG) unsuitable to children.

Preferred Multi Audio

Multi Audio

Select the language for multi broadcast.

If the selected language is not available, the original language will be selected.

Audio Description

(When Audio Description is available in the programme)

When "Automatic" is selected, Audio Description will be set as default while watching.



- When "Dolby Digital / Dolby Digital Plus", "MPEG" or "HE-AAC" is set to "Bitstream", the Audio Description may not work. Set them to "PCM" (⇒ 60, Digital Audio Output).

Preferred Subtitles

Subtitles

Choose the subtitle language for broadcast. If the selected language is not available, then the original language will be selected.

HbbTV Setting

Turn on/off the HbbTV service.

- When "On" is selected, HbbTV service are available.

HDD / USB HDD

Child Lock for Playback

You can restrict playback of the following titles:

- Titles that are recorded with guidance information
- Titles restricted by Child Lock List (⇒ 58)
(Titles with **G** icon in Video Menu, etc.)
- PIN is required to change. (⇒ 19)

Settings for Recording

REWIND LIVE TV

Turn on/off the REWIND LIVE TV function.

- When “Automatic Standby” is set to “Off” (⇒ 64), “On” cannot be selected.

Aspect for Recording

Sets the aspect ratio when recording or copying except in DR mode.

- “HG”, “HX”, “HE”, “HL” or “HM” mode:
If “Automatic” is selected, the title will be recorded with the original aspect ratio.
- “XP”, “SP” or “LP” mode:
If “Automatic” is selected, the title will be recorded with the original aspect ratio at the time when recording started (including when recording started at a commercial, etc.).
- “EP” mode:
If “Automatic” is selected, aspect is fixed to 4:3.

Chapter Creation

Set the Chapter Creation method.

- Even if “Automatic” is selected, depending on the programme to be recorded, the chapter may not be created correctly.

HDD Management

Press and hold [OK] for 3 seconds to show the following settings.

Delete all titles

Delete all recorded programmes and AVCHD on the built-in HDD.

- Delete does not work if one or more titles are protected.

Delete all videos (MP4 / Xvid / MKV)

Delete all videos (MP4/Xvid/MKV) on the built-in HDD.

Delete all photos

Delete all photos on the built-in HDD.

Delete all music

Delete all Music on the built-in HDD.

Format HDD

Formatting deletes all contents on the built-in HDD, and they cannot be restored. Check carefully before proceeding.

Settings for USB HDD

USB HDD Registration

Register the USB HDD. (⇒ 53)

USB HDD Disconnection

This function puts the USB HDD in a state in which it can be safely disconnected. (⇒ 53)

USB HDD Management

Press and hold [OK] for 3 seconds to show the following settings.

Delete all titles

Delete all titles on the USB HDD.

- Delete does not work if one or more titles are protected.

Format USB HDD

Formatting deletes all contents, and they cannot be restored. Check carefully before proceeding.

Cancellation of all USB HDD Registrations

This function cancels the registrations of all the USB HDDs registered on this unit.

Only do this if you are going to dispose of this unit.



- Before operation, perform “USB HDD Disconnection” (⇒ above) and remove the USB HDD.

Basic Settings

Picture

Still Mode

Select the type of picture shown when you pause play.

- **Field:**
Select if jittering occurs when "Automatic" is selected. (The picture is coarser.)
- **Frame:**
Select if small text or fine patterns cannot be seen clearly when "Automatic" is selected. (The picture is clearer and finer.)

Sound

Dynamic Range Compression

To lower the dynamic range for playback (e.g., at night).

- This does not work depending on broadcasts and recorded titles.

Downmix

Select the downmix system of multi-channel to 2-channels sound.

- Select "Surround encoded", when the connected equipment supports the virtual surround function.
- There is no effect on "Bitstream" via HDMI AV OUT and **HWT250** DIGITAL AUDIO OUT terminal.
- The audio will be output in "Stereo" in the following cases.
 - AVCHD playback

Bilingual Audio Selection

Select whether to record the audio type ("M1" or "M2") when:

- File Conversion (⇒ 38)

Digital Audio Output

HWT250 PCM Down Conversion

Select how to output audio with a sampling frequency of 96 kHz.

- **On:**
Signals are converted to 48 kHz. (Choose when the connected equipment cannot process signals with a sampling frequency of 96 kHz.)
- **Off:**
Signals are output as 96 kHz.
 - The signals will be converted to 48 kHz regardless of the setting in the following cases.
 - When the signals have a sampling frequency of over 96 kHz.

Dolby Digital/Dolby Digital Plus

MPEG

HE-AAC

Select the audio signal to output.

- Select "PCM" when the connected equipment cannot decode the respective audio format.
- Not making the proper settings may result in noise.

System Volume Adjustment

If the volume of a programme being watched through this unit is different than the volume of a programme being watched directly on the TV, changing this setting may reduce the gap. (This function works only while you are watching a programme or playing back a programme recorded in DR mode with this unit.)

Audio Delay

Mis-sync between the video and audio is corrected by delaying the audio output.

Display

On-Screen Information

Select the time until the channel information screen (⇒ 19) disappears automatically.

Screen Saver

This is to prevent image retention on the screen.

Connection

3D Settings

3D Type

If 3D video cannot be played back in 3D, you may be able to play it in 3D by changing the setting.

- Change the settings for 3D on the TV also when “Side by side” is selected.

3D AVCHD Output

If 2D AVCHD video is recognised as 3D video and cannot be played back correctly, you may be able to play it by changing the setting.

3D Playback Message

Set to display or hide the 3D viewing warning screen.

TV Aspect

Set to match the type of TV connected.

- 16:9:

When connected to a 16:9 widescreen TV.

- 4:3:

Side picture is trimmed for 16:9 picture.

The pictures may be shown in the letterbox style depending on the content.

- Letterbox:

Black bands appear for 16:9 picture.



Aspect for 4:3 Video

To play a 4:3 title, set how to show pictures on a 16:9 TV.

- 4:3:

Picture output expands left or right.

- 16:9:

Picture is output as original aspect with side panels.

TV System

Set in accordance with the TV System for the connected TV.

HDMI Connection

HDMI Video Format

You can only select items compatible with the connected equipment.

- If “Automatic” is selected, the output resolution best suited to the connected TV (1080p, 1080i, 720p or 576p/480p) is automatically selected.
- To enjoy High Quality Video up-converted to 1080p, you need to connect the unit to 1080p compatible HDTV. If this unit is connected to an HDTV through other equipment, it must also be 1080p compatible.

Deep Colour Output

Deep Colour output when a TV that supports Deep Colour is connected.

HWT250 HDMI Audio Output

Select “Off” when connected to an amplifier/receiver with a DIGITAL AUDIO OUT terminal.

Contents Type Flag

If “Automatic” is selected, the optimal method of playback depending on the TV (e.g. cinema) will automatically be selected (only when the TV supports Contents Type Flag).

VIERA Link

Select “Off” when you do not want to use VIERA Link.

Basic Settings

Network

Easy Network Setting

Press [OK] to start Easy Network Setting. (⇒ 16)

Network Settings

LAN Connection Mode

Select the LAN connection method.

- When not using wireless LAN (when turning it off), select “Wired”.

Wireless Settings

This allows to set and check the connection settings of the Wireless router.

Search for wireless network

WPS (PUSH button)

WPS (PIN code)

Manual Setting

Select a connection method to wireless access point.

IP Address / DNS Settings

Check the connection of the network or set the IP address and DNS.

- To set the IP address and DNS
 - 1 Set “IP Address Auto-assignment” and “DNS-IP Auto-assignment” to “Off”.
 - 2 Select the item, then press [OK] to show the respective setting.
- When the router’s DHCP server function is not activated, check the numbers of other connected devices such as personal computers, then assign a number different from those of other devices for the “IP Address” and assign the same number for “Subnet Mask” and “Gateway Address”.

Proxy Server Settings

Check and set the connection to the Proxy server.

- Press [OK] to show the respective setting.

Network Service Settings

Second Screen Browsing

When this function is set to “On”, you can enjoy the content you are viewing on a Network Service application of smartphone, etc. with the home network on the big screen of your TV.

Lock

You can restrict using Network Service.

- PIN is required to change. (⇒ 19)

Automatic Volume Control

Volume is adjusted automatically to the standard volume while using Network Service.

- Depending on contents, this function will not work.
- Select “Off” when the audio is warped.

Notice

Displays the terms of service for the cloud services.

- You must agree to the terms of use for the Internet function and the privacy policy.

TV Anywhere Settings

You must register to a service to use this function. (⇒ 51)

TV Anywhere

When you control this unit from a smartphone or a tablet away from home, set this function to "On". (⇒ 51)

Device ID

This is the device ID and device password required for registering to and using a service.

Initialize Device Password

The device password for this unit is initialized.

- When you initialize the device password, you will not be able to use TV Anywhere. To use the TV Anywhere again, you must re-register to the service.

Home Network Settings

You can set the DLNA (Server) function. (⇒ 47)

Home Network function

You can switch between enable/disable of the DLNA (Server) and DMR (Media Renderer) function.

- If "On" is selected, the setting for "Quick Start" is fixed to "On". (⇒ 64)
- If "Off" is selected, the setting for "TV Anywhere" and "Networked Standby" is fixed to "Off". (⇒ above, 64)
- When you set "Networked Standby" to "On", the setting for this function will also be changed to "On", but "Quick Start" will remain set to "Off".
- This cannot be set to "On" if the connection with the wireless broadband router is not encrypted in the wireless connection.

Setting device name

It is also possible to change the name of this unit on the network.

- Select from a preset list
Select the preset name, then press [OK].
- Create name
Enter the name.
Refer to "Entering text". (⇒ 67)

Conversion Setting for DLNA

- On:
When playing back on DLNA (Client) compatible equipment, this setting reduces the chance of break-ups and freezing of an image by lowering the image quality.



- When this is set to "On", switching the channel or starting playback will take longer.

Resolution Setting for DLNA

When "Conversion Setting for DLNA" is set to "On", select the image quality.

Registration type for remote devices

- Automatic:
All connected devices on the same network can access this unit.
- Manual:
Only registered devices can access this unit.

Remote device list

- To register equipment manually
 - 1 Select the device name or the MAC Address for the device you want to register, then press [OK].
 - 2 Select "Yes", then press [OK].
- To deregister equipment
 - 1 Select the registered equipment, then press [OK].
 - 2 Select "Yes", then press [OK].



- This function cannot be enabled when "Automatic" is selected in "Registration type for remote devices". (⇒ above)
- The maximum number of equipment that can be registered is 16.

Basic Settings

Others

Standby Settings

Quick Start

- On:
It is possible to start quickly from standby mode.
- Off:
Power consumption in standby mode is minimised. (⇒ 73)
However, startup time from standby mode will be longer.
- Timer Setting for Quick Start:
“Quick Start” is activated when the set time comes.



- When “Home Network function” (⇒ 63) or “TV Anywhere” (⇒ 63) is set to “On”, the setting for this function is fixed to “On”.

Automatic Standby

Set the time to turn the unit to standby mode automatically.

When the unit is not operating, the unit will be turned to standby mode once the set time has passed.

- When “REWIND LIVE TV” is set to “On” (⇒ 59), “Off” cannot be selected.

Automatic Standby after OTR

- On:
This unit is turned to standby mode when it is not operated for approximately 5 minutes after completing “Automatic Stop” or “Recording Time” (⇒ 24).

Automatic Standby after Copy

- On:
This unit is turned to standby mode when it is not operated for approximately 5 minutes after completing copy. (⇒ 40)

RF OUT (Aerial Signal)

Set whether to output the broadcasting signal from RF OUT or not while in standby mode (When “Quick Start” is not activated).

- If “On” is selected, the broadcasting signal is output from this unit.

Networked Standby

This unit can be turn on using a wake-up message sent from the network device in the home network. (Available only when “Quick Start” is set to “Off”.)

- On:
 - Power consumption increases when this unit is in standby mode. (⇒ 73)
 - This unit can be used as a DLNA Server when this unit is in standby mode. (This is possible if you have ever connected your client Panasonic recorder to the network using this unit as a server.)
- Off:
 - Power consumed when this unit is in standby mode becomes smaller than that consumed when “On” is selected. (⇒ 73)
 - When this unit is in standby mode, it cannot be used as a DLNA Server.
- When you change the “On/Off” setting of this function, the “On/Off” setting of “Home Network function” also changes.
- If “Quick Start” and “Home Network function” are set to “On”, even when this unit is turned off, it can be used as a DLNA Server.



- This function can be used with Panasonic recorders to be released from September 2015 and beyond.
- This function may not work correctly depending on network environment.

Remote Control

Change the remote control code on the main unit and the remote control if you place other Panasonic products close together.

- Use “Set Code 1”, the factory set code, under normal circumstances.
- 1 Select the code, then press [OK].
 - 2 While pressing [OK], press and hold the number button ([1] to [6]) for more than 5 seconds.
 - 3 Press and hold [OK] for more than 5 seconds.
 - 4 Press [OK].

Clock

If the time is not set correctly, use the settings listed in the method below.

- Manual Setting
 - 1 Select “Off” of “Automatic”, then press [OK].
 - 2 Select the item you want to change.
 - 3 Change the setting.
 - 4 Press [OK] when you have finished the settings.

Owner ID

In order to prevent another person from using this unit if it is stolen, you can set a PIN and input your personal information (NAME, HOUSE NO, POSTCODE).

Once the PIN has been set, you cannot return to the factory preset. Make sure not to forget this.

PIN Entry

You can set/change the PIN for parental control.

- 1 Enter your 4-digit PIN with the number buttons.
- 2 Enter the new 4-digit PIN with the number buttons.
 - **Make a note of PIN in case you forget it.**
 e.g.,

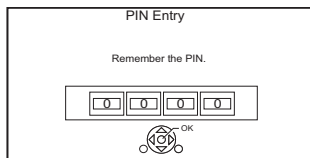

- 3 Press [OK].

System Update

Software Update in Standby

When you set this unit to standby mode, software (firmware) updates (⇒ 66) are downloaded automatically at the time you have specified.

Software Update Now (Broadcast)

Refer to “Software (Firmware) Update”.
(⇒ 66)

Software Update Now (Internet)

Refer to “Software (Firmware) Update”.
(⇒ 66)

Software Licence

Information about the software licence is displayed.

System Information

Display Software (firmware) version and Wireless Module version (When using wireless connection only) of this unit.

Initialize

Shipping Condition

All the settings except for some settings return to the factory preset.

- The timer recording programmes are also cancelled.
- The device password is also initialized.
(⇒ 63)

Default Settings

All the settings other than the tuning settings, clock settings, remote control code, device password, etc. return to the factory presets.

4K Networking

You can save 4K videos/photos recorded with digital cameras and other 4K-compatible devices to the HDD of this unit and play them back.

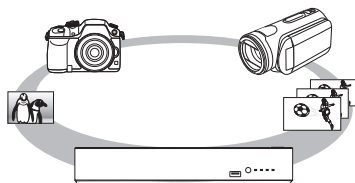

Compatible 4K content

- MP4/MOV (4K/24p, 25p and 30p)
 - bit rate up to 100 Mbps
 - resolution up to 3840×2160 25p/30p, 4096×2160 24p
- JPEG, MPO
 - resolution 3840×2160
 Photos with a resolution greater than 3840×2160 are played back in 3840×2160.

Preparation

- Connect a 4K-compatible TV to this unit. (⇒ 12)

Playing back 4K content

■ 4K videos

HDD

Refer to “Playing titles on the HDD”. (⇒ 31)

USB

Refer to “Playing titles on the media”. (⇒ 33)

■ Photos

Refer to “Playing photos”. (⇒ 41)



- Video may not be played back smoothly depending on the USB device.
- You can also watch the 4K contents stored in the DLNA Certified media server. (⇒ 47, Smart Home Networking (DLNA))

Copying 4K content

■ 4K videos

USB



HDD

Refer to “Copying video files”. (⇒ 40)

■ Photos

Refer to “Copying photos”. (⇒ 44)

Software (Firmware) Update

You cannot operate the unit until the update is complete. Don't remove the AC mains lead during the update. Removing the AC mains lead while the update is in progress may damage the unit.

Update software (firmware) of this unit

Software of this unit can be updated automatically by the following methods at the specified time.

• From broadcasts

(Default setting is 3 a.m. ⇒ 65, Software Update in Standby)

• From Internet

Network connection and setting are required. (⇒ 13, 16)



- About displays on this unit during software update. (⇒ 72)

If a software (firmware) update is available, a notification is displayed.

New software version has been found. The software will be updated automatically after this unit is switched to standby. Do not disconnect the AC mains lead.

Update of the software (firmware) will start when the unit is turned to standby mode.

To update the software (firmware) immediately

Use the “Software Update Now (Broadcast)” function or “Software Update Now (Internet)” function. (⇒ 65)



- It may take up to a few hours until the update is completed depending on the network environment.
- The timer recording always takes preference over the software (firmware) download; if the timer recording is scheduled to start, the downloading will be performed at the next opportunity.
- For the latest firmware update information, please refer to the Panasonic support site below.
- You can also download the latest software (firmware) from the following website.
<http://panasonic.jp/support/global/cs/>

Other operations

HOLD function

The HOLD function deactivates all buttons on the unit and remote control.

Press and hold [OK] and [BACK/RETURN] simultaneously for at least 5 seconds until the "REC", "INFO1" and "INFO2" indicators on this unit all flash for 5 seconds.

To cancel the HOLD function

Press and hold [OK] and [BACK/RETURN] simultaneously for at least 5 seconds until the "REC", "INFO1" and "INFO2" indicators on this unit stop flashing and go off.

Entering text

Preparation

- Show the "Enter Title Name" screen, etc.

- 1 Select a character, then press [OK].
Repeat this step to enter other characters.

e.g.,

Name field: shows the text you have entered

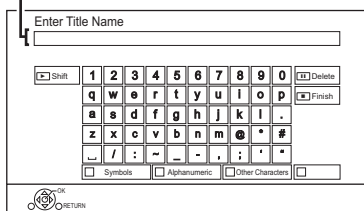

- Green: Enter Alphanumeric characters
 - Red: Enter Symbols
 - Yellow: Enter Other Characters, such as umlaut mark or accent grave
 - [PAUSE ■■■]: Delete a character
 - [PLAY/× 1.3 ▶]: Shift the alphabetic characters on the screen to upper case/lower case
- 2 Press [STOP ■] (Finish).
"Writing..." appears then the screen returns to the previous screen and so on.

To end partway

Press [BACK/RETURN]. (Text is not added.)



- The maximum number of characters depends on the media.

Switching the aspect ratio of the screen

When the image does not match the screen size of the TV, you can enlarge the image to fill the screen.

- 1 Press [OPTION].
- 2 Select "Playback Settings" in "Playback Menu", then press [OK].
- 3 Select "Aspect" in "Basic Operation", then press [OK].
- 4 Select the item, then press [OK].

Normal:

Normal output

Side cut:

The black bars on the right and left sides of the 16:9 image disappear and the image is enlarged.

Zoom:

The black bars on the top and bottom sides of the 4:3 image disappear and the image is enlarged.



- This function does not work on 3D contents.
- The screen mode is switched to "Normal" in the following situations:
 - when you change the channel
 - when you start or end the playback of a title
 - when you switch the unit on or to standby mode.
- When "TV Aspect" (⇒ 61) is set to "4:3" or "Letterbox", the "Zoom" effect is disabled.

Troubleshooting guide

Before requesting service, make the following checks. If the problem still persists, consult your dealer for instructions.

Updating to the latest software (firmware) may solve the problem. (⇒ 66)

The followings do not indicate a problem with this unit:

- HDD rotating sounds.
- Poor reception due to atmospheric conditions.
- When you switch the unit on or to standby mode, there may be an unexpected sound.

General operation

The unit does not work.

- Check the connections. (⇒ 12)
- One of the unit's safety devices may have been activated.

Reset the unit as follows:

- 1 Press [⏻/|] on the main unit to switch the unit to standby.
 - If the unit does not switch to standby, press [⏻/|] on the main unit for about 3 seconds. The unit is forcibly switched to standby. Alternatively, disconnect the AC mains lead, wait one minute, then reconnect it.
- 2 Press [⏻/|] on the main unit to switch it on. If the unit still cannot be operated, consult the dealer.

Startup is slow.

- Startup takes time in the following situations: Please wait.
 - The clock is not set.
 - Immediately after a power failure or the AC mains lead is connected.
 - When the "Quick Start" is not activated. (⇒ 64)

TV screen and video

Screen size is wrong.

- Check the "TV Aspect" or "Aspect for 4:3 Video". (⇒ 61)
- Adjust the aspect ratio setting on TV.
- Adjust the aspect ratio setting on this unit. (⇒ 67)
- Check "Aspect for Recording" before recording or file conversion. (⇒ 59)

The black screen appears on the TV.

- This phenomenon may occur, depending on the TV setting, when "Quick Start" is activated. Depending on the TV, this phenomenon may be prevented by reconnecting to a different HDMI input terminal.

TV reception is not displayed.

- Broadcast signals are not output from this unit's RF OUT terminal. Select "On" in "RF OUT (Aerial Signal)". (⇒ 64)

The screen changes automatically.

- If "Screen Saver" is set to "On", the screen saver function will be activated when there is no operation for 5 minutes or more. (⇒ 61)

There is a lot of image lag when playing video.

- Set to "0" all items in the "Noise Reduction". (⇒ 56)
- Set "Audio Delay". (⇒ 60)

The remote control does not work.

- The remote control and main unit are using different codes. Change the code on the remote control.

"Remote Control □" appears on the right side of the screen.

("□" stands for a number.) (⇒ 65, Remote Control)

**The images do not appear on the TV.
The picture is distorted during play, or video
is not played correctly.**

- Check the connections. (⇒ 12)
- Check the settings of the connected TV, etc.
- An incorrect resolution is selected in "HDMI Video Format". (⇒ 61) Reset the setting as follows:
 - 1 While the unit is on, press and hold [OK], the yellow button and the blue button at the same time for more than 5 seconds.
 - The "INFO1" indicator on the unit will flash.
 - 2 Press [▶] repeatedly until the "REC" and "INFO2" indicators on this unit start flashing.
 - 3 Press and hold [OK] for at least 3 seconds. Set the item again.
- Picture may not be seen when more than 4 devices are connected with HDMI cables. Reduce the number of connected devices.
- The picture may be distorted or a black screen may appear between scenes recorded with different aspect ratios.
- Set "Deep Colour Output" (⇒ 61) or "Contents Type Flag" (⇒ 61) to "Off".

3D video is not output correctly.

- 3D video may be output correctly by changing the following settings:
 - "3D Type" of "3D Settings" (⇒ 61)
 - "Signal Format" (⇒ 36, 3D settings during playback)
- Check the settings of the connected TV.
- When a non-3D compatible amplifier/receiver is connected between this unit and a TV, 3D video is not output. (⇒ 13)
- **HWT250** When "HDMI Audio Output" is set to "Off", 3D video may not be output correctly. (⇒ 61)

Sound

No sound.

Distorted sound.

- Check the connections. (⇒ 12)
- Check the settings of the connected TV, etc.
- Select the audio with "Multi Audio". (⇒ 19, 35)
- **HWT250** To output audio from a device connected with an HDMI cable, set "HDMI Audio Output" to "On". (⇒ 61)

Cannot change audio channel.

- You cannot change the audio channel if "Digital Audio Output" is set to "Bitstream" (⇒ 60)

Recording, timer recording and copying

Cannot record.

Cannot copy.

- Some broadcasts are copyright protected.

Timer recording does not work properly.

- When  is displayed on the screen. (⇒ 30)
- Because the actual broadcast time may be different from the time displayed on the TV Guide, we recommend you set the start time earlier and the end time later by some minutes, up to a maximum of 10 minutes.

Troubleshooting guide

The timer recording programmed via Network Service does not work properly.

- Timer recording programmed via Network Service will be recorded with the same conditions as those of manual timer recording, and some functions such as "Guide Link" (⇒ 27) does not work.

Auto Renewal Recording does not work properly.

- The programme will not be overwritten in the following cases:
 - the programme is protected
 - any programme is being played back or copied
 - a screen such as Video Menu is displayed
 Instead, the programme will be saved as a separate programme and that will be overwritten.

A part or whole of a recorded title has been lost.

If there is a power failure or the AC mains lead is disconnected from the household mains socket while recording or editing, the title may be lost or the HDD may become unusable. We cannot offer any guarantee regarding lost programmes.

Play

You have forgotten your rating PIN number for parental control.

- The PIN number for parental control and the rating level return to the factory preset. The default PIN number is "0000".
 - 1 While the unit is on, press and hold [OK], the yellow button and the blue button at the same time for more than 5 seconds.
 - The "INFO1" indicator on the unit will flash.
 - 2 Press [▶] repeatedly until the "INFO2" indicator on this unit starts flashing.
 - 3 Press [OK].

Image for the Quick View is not smooth.

- Image may not be played back smoothly in case of high definition titles.

Edit

Cannot edit.

- You may not be able to edit on the HDD if there is no available space. Delete any unwanted titles to create empty space. (⇒ 37)

Photo

Photos do not play back normally.

- The images that were edited on the PC, such as Progressive JPEG, etc., may not play back. (⇒ 7)

USB

This unit does not recognize the USB device correctly.

- If inserted during playback the USB device may not be recognized by this unit. Disconnect and reconnect the USB device. If it still does not recognize the connection, switch the unit to standby mode and turn it on again.
- USB devices connected using a USB extension cable other than a dedicated one or a USB hub may not be recognized by this unit.

TV Guide

The TV Guide information is not displayed properly.

- Set the clock correctly. (⇒ 65, Clock)
- There was a programme change, or TV Guide information from a broadcast station was possibly not correctly transmitted.
- If signal quality is bad, the TV Guide may not be able to receive any data.
- It may take time until the TV Guide screen is displayed correctly. Wait for about a day.

Broadcast

Picture regularly breaks up on some channels.

- Adjust the reception with "Manual Tuning". (⇒ 58)

Network

You cannot access this unit from DLNA compatible equipment on the network.

- Check the network connection and the network settings. (⇒ 13, 16)
- It may not be possible to connect depending on the types of the equipment or the status of the equipment.

When using this unit as a server, video frames are dropped.

- Change the following settings:
 - Conversion Setting for DLNA (⇒ 63)
 - Resolution Setting for DLNA (⇒ 63)

You cannot play contents properly from DLNA compatible equipment on the network.

- There may be some video that cannot be played back on DLNA compatible equipment depending on the equipment.
- Following titles may not be played back:
 - A title with access restriction
 - A title with incompatible format
- Playback via DLNA compatible equipment may not be performed when this unit is in the following conditions:
 - While simultaneously performing High speed copy and recording
 - While displaying the Basic Settings menu
 - While executing functions using a network, such as Network Service
- If the DLNA compatible equipment is not capable of outputting HE-AAC audio format, etc., sound may not be played back.
- When "Automatic" is set for "Audio Description" (⇒ 20), some parts of Home Network function cannot be used.
Set "Audio Description" to "Off".

When using Wireless LAN connection, video from the DLNA Certified media server is not played back or video frames are dropped during playback.

- Use 802.11n (2.4 GHz or 5 GHz) Wireless router.
Simultaneous use with a microwave, cordless telephone etc. at 2.4 GHz may result in connection interruptions or other problems.
- On the "Wireless Settings" screen (⇒ 62), the continuous lighting of at least four "Reception" indicators is the target for a stable connection. If three or fewer indicators are lit or the connection is being interrupted, change the position or angle of your Wireless router. If there is no improvement, connect to a wired network and perform the "Easy Network Setting" (⇒ 16, 62) again.

Reset

To return all the settings to the factory preset

Perform "Shipping Condition" or "Default Settings". (⇒ 65)

Troubleshooting guide

LED indicators on the front panel

The front panel indicators of this unit light up or flash in order to show the unit's condition. Refer to the table below to identify the condition.

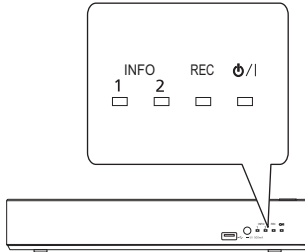

LED indicators	Check the following
When this unit is in standby mode "INFO2", (⏻/I) light up.	A software (firmware) update is in progress. Never disconnect the AC mains lead until "INFO2" and (⏻/I) go off. Doing so may cause malfunctions. (⇒ 66)

LED indicators	Check the following
"INFO1", "INFO2", "REC" flash for 5 seconds.	The HOLD function is activated. (⇒ 67)
"INFO1" flashes 6 times, "INFO2" goes off.	The remote control does not work. (⇒ 65)
"INFO1", "REC" light up, "INFO2" flashes fast.	The USB device is drawing too much power. Remove the USB device.
"INFO1", "REC" light up, "INFO2" goes off.	The unit is hot. The unit switches to standby for safety reasons. Wait for about 30 minutes until the indicators go off. Install or place this unit with good ventilation.
"INFO1", "REC" light up, "INFO2" flashes.	An abnormality has been detected in the power supply to the antenna. Check to see if the core wires and braided wire are in contact with each other within the antenna cable.
"INFO1", "INFO2" light up, "REC" goes off.	HDMI cannot be output because it is connected to a model that does not support copyright protection.
"INFO1" lights up, "REC" flashes.	A malfunction has occurred. The unit is trying to restore to the normal operation. Once the indicators go off you can use the unit again. If it remains stays on, consult the dealer.
"INFO1", "INFO2" light up, "REC" flashes.	The unit fails to operate properly. Press [⏻/I] on the main unit to switch the unit to standby mode. Now press [⏻/I] on the main unit again to turn the unit on.

Specifications

Specifications are subject to change without notice.

■ General

Dimensions: 300 mm (W)
52 mm (H)
(including the projecting parts)
190 mm (D)

Mass: **HWT250** Approx. 1.6 kg
HWT150 Approx. 1.2 kg

Power supply: AC 220 V to 240 V, 50 Hz

Power consumption: **HWT250** Approx. 22 W
HWT150 Approx. 16 W

Power consumption in Networked Standby mode :

“Quick Start” is not activated and “Networked Standby” is set to “On”.

Approx. 1 W

Power consumption in Standby mode :

“Quick Start” is not activated,
“Networked Standby” is set to “Off” and “RF OUT (Aerial Signal)” is set to “Off”.

Approx. 0.2 W

Operating temperature: 5 °C to 40 °C

Operating humidity range: 10 % to 80 % RH
(no condensation)

■ TV system

Tuner System: DVB-T/T2

Country: UK

Channel Coverage: UHF 21~68

■ Video/Audio terminals

HWT250 Digital audio out (coaxial): 1 pc.

HDMI out (19 pin type A): 1 pc.

■ Internal HDD capacity

HWT250 1 TB

HWT150 500 GB

■ Other terminals

USB Port (Type A): USB2.0

HWT250 2 pcs.

HWT150 1 pc.

LAN (Ethernet) Port: 1 pc.

10BASE-T/100BASE-TX

■ Wireless LAN

Standard compliance: IEEE802.11a/b/g/n

Frequency range: 2.4 GHz/5 GHz band

Security*:

WPA™/WPA2™

(Encryption type: TKIP/AES,

Authentication type: PSK)

WEP (64 bit/128 bit)

* This unit supports WPA™ and WPA2™ encryption.

Recording modes and approximate recording times

Depending on the content being recorded, the recording time may become shorter than indicated.

■ DR mode

Recording Mode	HDD	
	HWT250 (1 TB)	HWT150 (500 GB)
DR (HD quality)	259 hours	129 hours
DR (SD quality)	518 hours	258 hours

• Recording time of DR mode may vary depending on the bit rate of broadcasting:

- High Definition (HD) quality: estimated bit rate is 8 Mbps
- Standard Definition (SD) quality: estimated bit rate is 4 Mbps

• Regarding recording time remaining:

Remaining time in the DR mode is calculated with a bit rate of 8 Mbps. But the bit rate differs depending on the broadcast, so the displayed remaining time might be different from the actual remaining time.

■ HG, HX, HE, HL, HM modes

Recording Mode	HDD	
	HWT250 (1 TB)	HWT150 (500 GB)
HG	157 hours	78 hours
HX	235 hours	117 hours
HE	353 hours	176 hours
HL	472 hours	235 hours
HM	684 hours	341 hours

Specifications

■ XP, SP, LP, EP modes

Recording Mode	HDD	
	HWT250 (1 TB)	HWT150 (500 GB)
XP	215 hours	107 hours
SP	431 hours	215 hours
LP	862 hours	430 hours
EP	1724 hours	860 hours

• Regarding recording time remaining:

This unit records using a VBR (Variable bit rate) data compression system to vary recorded data segments to match video data segments which may cause differences in the displayed amount of time and space remaining for recording.

Audio information

The audio output differs depending on which terminals are connected to the amplifier/receiver, and the setting on this unit. (⇒ 60, Digital Audio Output)

- The maximum possible number of Dolby® sound is 2ch PCM.



Declaration of Conformity (DoC)

Hereby, "*Panasonic Corporation*" declares that this product is in compliance with the essential requirements and other relevant provisions of Directive 1999/5/EC.

Customers can download a copy of the original DoC to our R&TTE products from our DoC server:
<http://www.doc.panasonic.de>

Contact to Authorised Representative: Panasonic Marketing Europe GmbH,
 Panasonic Testing Centre, Winsbergring 15, 22525 Hamburg, Germany

This product is intended to be used in the following countries.

Austria, Belgium, Bulgaria, Cyprus, Czech Republic, Denmark, Finland, France, Germany, Greece, Hungary, Ireland, Italy, Iceland, Liechtenstein, Luxembourg, Malta, Netherlands, Norway, Poland, Portugal, Romania, Slovakia, Slovenia, Spain, Sweden, United Kingdom, Switzerland

This product is intended for general consumer. (Category 3)

The WLAN feature of this product shall exclusively be used inside buildings.

This product on purpose to connect to access point of 2.4 GHz or 5 GHz WLAN.

Personal information handling

To provide functions and services of this unit, a device ID, device password and usage history information are stored and managed securely in an appropriate security environment of Panasonic. Please note that usage history and other information may be collected for purposes such as improving products and services in such a way that individuals cannot be identified.

Disposal of Old Equipment and Batteries Only for European Union and countries with recycling systems



These symbols on the products, packaging, and/or accompanying documents mean that used electrical and electronic products and batteries must not be mixed with general household waste.

For proper treatment, recovery and recycling of old products and used batteries, please take them to applicable collection points in accordance with your national legislation.

By disposing of them correctly, you will help to save valuable resources and prevent any potential negative effects on human health and the environment.

For more information about collection and recycling, please contact your local municipality.



Penalties may be applicable for incorrect disposal of this waste, in accordance with national legislation.



Note for the battery symbol (bottom symbol):

This symbol might be used in combination with a chemical symbol. In this case it complies with the requirement set by the Directive for the chemical involved.

Licenses

<p>"AVCHD", "AVCHD 3D", "AVCHD Progressive" and "AVCHD 3D/Progressive" are trademarks of Panasonic Corporation and Sony Corporation.</p>
<p>DLNA, the DLNA Logo and DLNA CERTIFIED are trademarks, service marks, or certification marks of the Digital Living Network Alliance.</p>
<p>DVB and the DVB logos are trademarks of the DVB Project.</p>
<p>MPEG Layer-3 audio coding technology licensed from Fraunhofer IIS and Thomson.</p>
<p>Manufactured under license from Dolby Laboratories. Dolby and the double-D symbol are trademarks of Dolby Laboratories.</p>
<p>This product is licensed under the AVC patent portfolio license for the personal use of a consumer or other uses in which it does not receive remuneration to (i) encode video in compliance with the AVC Standard ("AVC Video") and/or (ii) decode AVC Video that was encoded by a consumer engaged in a personal activity and/or was obtained from a video provider licensed to provide AVC Video. No license is granted or shall be implied for any other use. Additional information may be obtained from MPEG LA, L.L.C. See http://www.mpegla.com</p>
<p>This product is licensed under the VC-1 patent portfolio license for the personal and non-commercial use of a consumer to (i) encode video in compliance with the VC-1 Standard ("VC-1 Video") and/or (ii) decode VC-1 Video that was encoded by a consumer engaged in a personal and non-commercial activity and/or was obtained from a video provider licensed to provide VC-1 video. No license is granted or shall be implied for any other use. Additional information may be obtained from MPEG LA, L.L.C. See http://www.mpegla.com</p>
<p>The Wi-Fi CERTIFIED™ Logo is a certification mark of Wi-Fi Alliance®. The Wi-Fi Protected Setup™ Identifier mark is a certification mark of Wi-Fi Alliance®.</p> <div style="text-align: right;">   </div>
<p>"Wi-Fi®" and "Wi-Fi Direct®" are registered trademarks of Wi-Fi Alliance®. "Wi-Fi Protected Setup™", "Miracast™", "WPA™", and "WPA2™" are trademarks of Wi-Fi Alliance®.</p>
<p>HDMI, the HDMI Logo, and High-Definition Multimedia Interface are trademarks or registered trademarks of HDMI Licensing LLC in the United States and other countries.</p>
<p>Windows is a trademark or a registered trademark of Microsoft Corporation in the United States and other countries.</p>

<p>This product incorporates the following software:</p> <ol style="list-style-type: none"> (1) the software developed independently by or for Panasonic Corporation, (2) the software owned by third party and licensed to Panasonic Corporation, (3) the software licensed under the GNU General Public License, Version 2.0 (GPL V2.0), (4) the software licensed under the GNU LESSER General Public License, Version 2.1 (LGPL V2.1), and/or (5) open source software other than the software licensed under the GPL V2.0 and/or LGPL V2.1. <p>The software categorized as (3) - (5) are distributed in the hope that it will be useful, but WITHOUT ANY WARRANTY, without even the implied warranty of MERCHANTABILITY or FITNESS FOR A PARTICULAR PURPOSE. Please refer to the detailed terms and conditions thereof shown in the Basic Settings menu.</p> <p>At least three (3) years from delivery of this product, Panasonic will give to any third party who contacts us at the contact information provided below, for a charge no more than our cost of physically performing source code distribution, a complete machine-readable copy of the corresponding source code covered under GPL V2.0, LGPL V2.1 or the other licenses with the obligation to do so, as well as the respective copyright notice thereof. Contact Information: oss-cd-request@gg.jp.panasonic.com</p> <p>The source code and the copyright notice are also available for free in our website below. http://panasonic.net/avc/oss/</p>
<p>Vorbis, FLAC, WPA Supplicant</p> <p>The software licenses are displayed when "Software Licence" in the Basic Settings menu is selected. (⇒ 65)</p>
<p>The Freeview service and channels are subject to coverage and may be changed from time to time. Aerial upgrade and/or receiver may be required. Visit freeview.co.uk/availability.</p> <p>The FREEVIEW words and logos are trade marks of DTV Services LTD. © DTV Services Ltd</p> <p>Minimum broadband speed of 2mbps required for catch up and on demand services.</p> <p>Watching on demand and catch up programmes will count towards any monthly broadband data allowance.</p>
<p>Android is a trademark of Google Inc.</p>
<p>MS/PlayReady/Final Product Labeling</p> <p>This product contains technology subject to certain intellectual property rights of Microsoft. Use or distribution of this technology outside of this product is prohibited without the appropriate license(s) from Microsoft.</p> <p>MS/PlayReady/End User Notices</p> <p>Content owners use Microsoft PlayReady™ content access technology to protect their intellectual property, including copyrighted content. This device uses PlayReady technology to access PlayReady-protected content and/or WMDRM-protected content. If the device fails to properly enforce restrictions on content usage, content owners may require Microsoft to revoke the device's ability to consume PlayReady-protected content.</p> <p>Revocation should not affect unprotected content or content protected by other content access technologies. Content owners may require you to upgrade PlayReady to access their content. If you decline an upgrade, you will not be able to access content that requires the upgrade.</p>
<p>Rovi and Rovi Guide are trademarks of Rovi Corporation and/or its subsidiaries.</p> <p>The Rovi Guide system is manufactured under license from Rovi Corporation and/or its subsidiaries.</p> <p>The Rovi Guide system is protected by patents and patent applications filed in the US, Europe, and other countries including one or more of the United States patents 6,396,546; 5,940,073; 6,239,794 issued to Rovi Corporation and/or its subsidiaries.</p> <p>Rovi Corporation and/or its subsidiaries and related affiliates are not in any way liable for the accuracy or availability of the program schedule information or other data in the Rovi Guide system and cannot guarantee service availability in your area. In no event shall Rovi Corporation and/or its related affiliates be liable for any damages in connection with the accuracy or availability of the program schedule information or other data in the Rovi Guide system.</p> 

Index

A	
Aspect	61, 67
Audio	19, 35, 74
Audio Description (AD)	20, 35, 58
Auto Setup	14, 57
AVCHD	31, 33, 52
B	
Basic Settings	57
C	
Channel information	19
Channel List	57
Chapter	32, 35, 39, 59
Child Lock	58, 59
HOLD function	67
Clock	65
Connection	
Network	13
Copy	40
AVCHD	52
D	
Delete	
Music	46
Photo	43
Video	37
E	
Easy setting	14
Entering text	67
F	
Favourites	57
Format	
HDD	59
USB HDD	59
Freeview	27
Freeview Play Catch up	23
FUNCTION MENU	18
H	
HDD	
Format	59
Media information	6
L	
LED indicators	72
M	
Manual Tuning	58
Media Renderer	49
Menu screen	33
Miracast™	50
Music	45
N	
Network	
Connection	13
Easy Network Setting	16, 62
Miracast™	50
Network Service	51
Smart Home Networking (DLNA)	47, 63
Wi-Fi Direct®	50

P	
PAUSE LIVE TV	21
Photo	41
PIN	19, 65
Playback menu	55
Protection	
Video	37
Q	
Quick Start	64
R	
Recording	24
Recording mode	73
Timer recording	26
Recording mode	73
Recording time	73
Remote control	10
HOLD function	67
Remote control code	65
TV operation	14
Reset	65, 70, 71
REWIND LIVE TV	21, 59
S	
Setting	
Auto Setup	14, 57
Easy setting	14
Slideshow	42
Smart Home Networking (DLNA)	47, 63
Client	48
Media Renderer	49
Server	47
Software (Firmware) Update	66
T	
Timer recording	26
Troubleshooting guide	68
LED indicators	72
Tuning	
Channel List	57
Channel Sorting by Region	58
Child Lock	58
Manual Tuning	58
Signal condition	58
TV Anywhere	51
TV Guide	
Operation	22
Timer recording	26
TV System	61
U	
USB HDD	
Cancellation of all USB HDD Registrations	59
Disconnection	53, 59
Format	59
Media information	6, 8
Registration	53, 59
USB memories	
Media information	6, 8
V	
Video	
AVCHD	31, 33
Copy	40
Delete	37
MKV	33
Playback	31, 33
Protection	37
Recording	24
Video Menu	31
Xvid	7
3D	36
VIERA Link	54, 61
W	
Wi-Fi Direct®	50
X	
Xvid	7
3D	36
4K Networking	66
7 days back function	23

Sales and Support Information

Customer Communications Centre

- For customers within the UK: 0344 844 3899
- For customers within Ireland: 01 289 8333
- Monday - Friday 9:00 am - 5:00 pm (Excluding public holidays).
- For further support on your product, please visit our website: www.panasonic.co.uk

Direct Sales at Panasonic UK

- Order accessory and consumable items for your product with ease and confidence by phoning our Customer Communications Centre Monday - Friday 9:00 am - 5:00 pm (Excluding public holidays).
- Or go on line through our Internet Accessory ordering application at www.pas-europe.com.
- Most major credit and debit cards accepted.
- All enquiries transactions and distribution facilities are provided directly by Panasonic UK.
- It couldn't be simpler!
- Also available through our Internet is direct shopping for a wide range of finished products. Take a browse on our website for further details.

To get the most up to date service from Freeview it is important for Freeview customers to retune from time to time.

How do I re-tune my Freeview Box?

The below instructions are a quick reference. If you have any problems, check your instruction manual or ask a friend or family member to show you how. Alternatively, go to your local electrical retailer, contact your manufacturer or visit freeview.co.uk/retune

Re-tuning only takes a few minutes, just follow the steps below:

- 1 Press [FUNCTION MENU].
- 2 Select "Basic Settings" in "Setup", then press [OK].
- 3 Select "Auto Setup" in "Tuning", then press [OK].
- 4 Select "Yes", then press [OK].

Please note: most digital TV recorders will keep your original recordings after running a re-tune but you will need to reset any future recordings.

For detailed information on re-tuning your receiver please refer to page 57 of this instruction book.

Manufactured by: Panasonic Corporation
Kadoma, Osaka, Japan
Importer for Europe: Panasonic Marketing Europe GmbH
Panasonic Testing Centre
Winsbergring 15, 22525 Hamburg, Germany



Panasonic Corporation
Web Site: <http://www.panasonic.com>

En

SQT0993

F0915TA0